

Spring 2018 Group Update

Jonathan Nikoleyczik

Today's update starts on [slide 34](#)

Current tasks

- Gamma-X events from calibration sources
 - Simulate LZ calibrations and see how they are impacted by gamma-x events
- Phase 1 optical maps
 - Improve the speed and accuracy of Phase 1 sims by adding in a map for S2 events
- Phase 1 Run 7 data analysis
- LUX 100T projection sensitivity paper
- LZ scale model

Gamma-X from calibration sources

Possible sources:

- AmLi (AmBe)
- ^{252}Cf
- ^{228}Th
- ^{57}Co (As a test)

All are CSD sources. Generate them in CSD tubes, located in the vacuum space, at $z=0$ (cathode)

Table 7.0.1: Baseline calibration sources for LZ.

Isotope	What	Purpose	Deployment	Custom?
Tritium	beta, $Q = 18.6$ keV	ER band	Internal	N
$^{83\text{m}}\text{Kr}$	beta/gamma, 32.1 keV and 9.4 keV	TPC (x, y, z)	Internal	Y
$^{131\text{m}}\text{Xe}$	164 keV γ	TPC (x, y, z), Xe skin	Internal	Y
^{220}Rn	various α 's	xenon skin	Internal	N
AmLi	(α, n)	NR band	CSD	Y
^{252}Cf	spontaneous fission	NR efficiency	CSD	N
^{57}Co	122 keV γ	Xe skin threshold	CSD	N
^{228}Th	2.615 MeV γ , various others	OD energy scale	CSD	N
^{22}Na	back-to-back 511 keV γ 's	TPC and OD sync	CSD	N
^{88}Y Be	152 keV neutron	low-energy NR response	External	N
^{205}Bi Be	88.5 keV neutron	low-energy NR response	External	Y
^{206}Bi Be	47 keV neutron	low-energy NR response	External	Y
DD	2,450 keV neutron	NR light and charge yields	External	N
DD	272 keV neutron	NR light and charge yields	External	Y
^{133}Ba	356 keV gamma	OD and TPC	CSD	N
^{60}Co	1173, 1333 keV gamma	OD, TPC energy scale	CSD	N
^{124}Sb	23 keV neutron	low-energy NR response	External	N

Calibration results (Cf252)

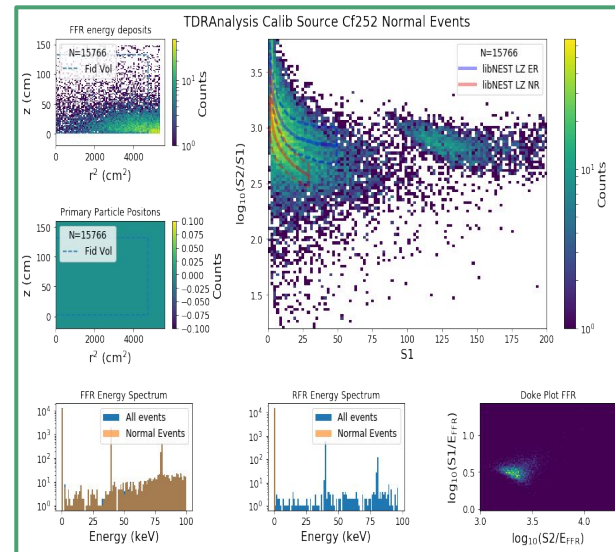
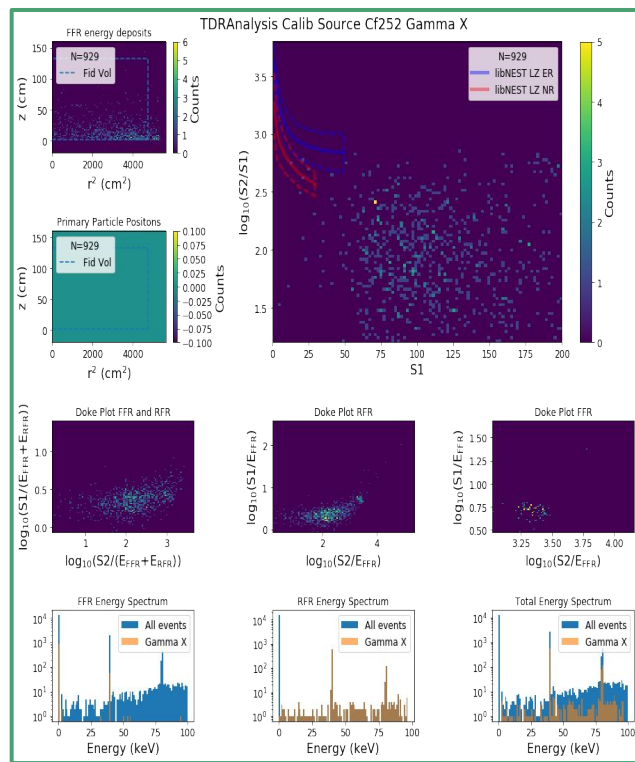
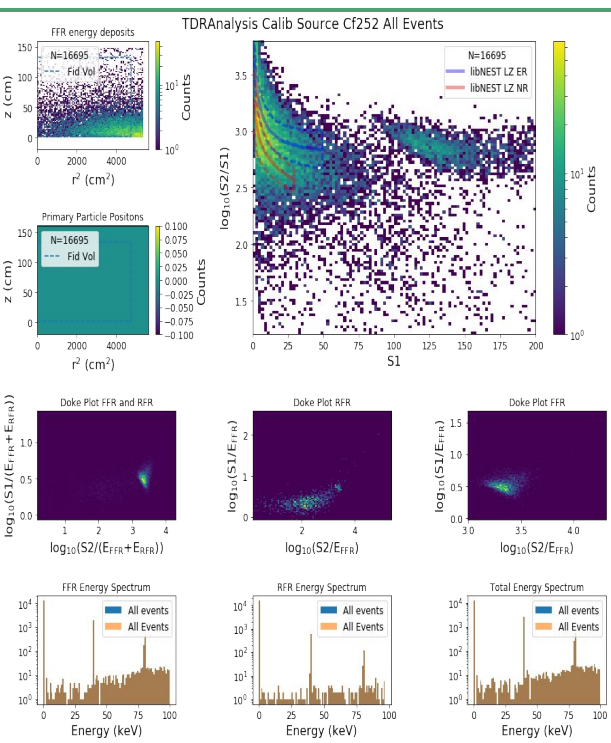

Calibration results (Cf252) Single Scatter and FV cuts

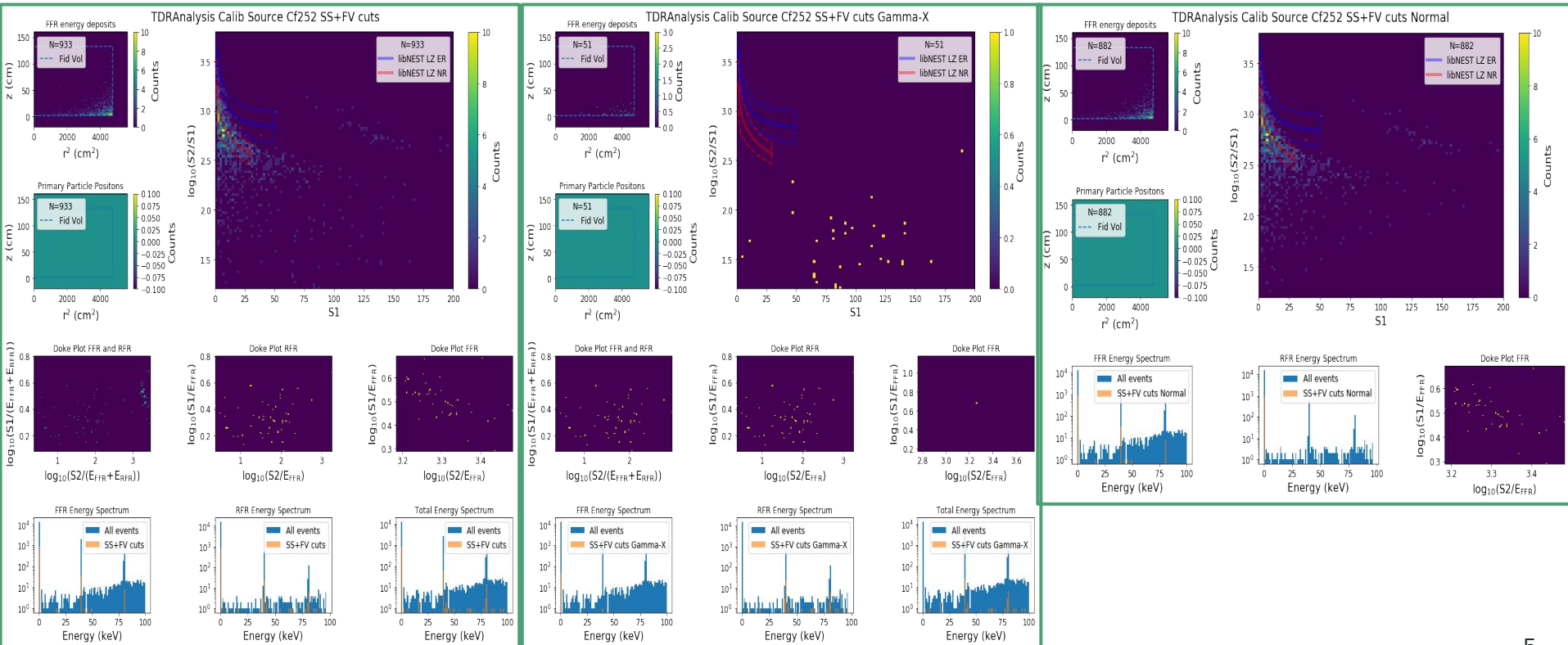

Calibration results

- AmLi (AmBe)
 - Only AmBe working in BACCARAT
 - Results are similar to shown for ^{252}Cf
- ^{252}Cf
 - Little impact of gamma-x at low energies
 - Potentially 1% gamma-x contribution at higher energies
- ^{228}Th
 - Events seen are near the walls
 - None are gamma-x
 - Nice ER band S1/S2 spectrum
- ^{57}Co
 - 2/2,000,000 events made it into the liquid
 - Neither of them were gamma-x

Phase 1 optical maps

- Used the scripts from Amy to make maps of ~ 10 million photons distributed in the liquid xenon for S1s and in the gas for S2s
- Implemented in BACCARAT
- Leaves LZ sims intact and unaffected
- Simply calls the phase 1 map instead if running phase 1 sims

Phase 1 photon maps (S1)

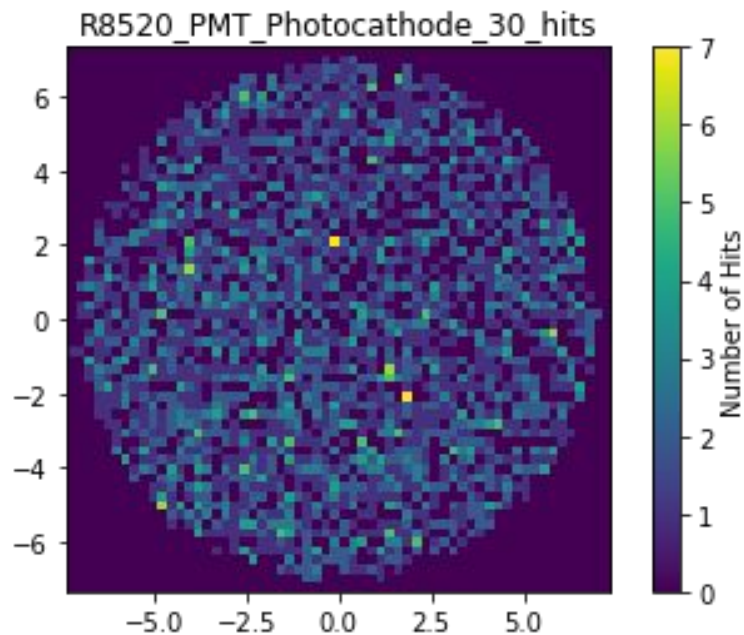

Example of a single PMT

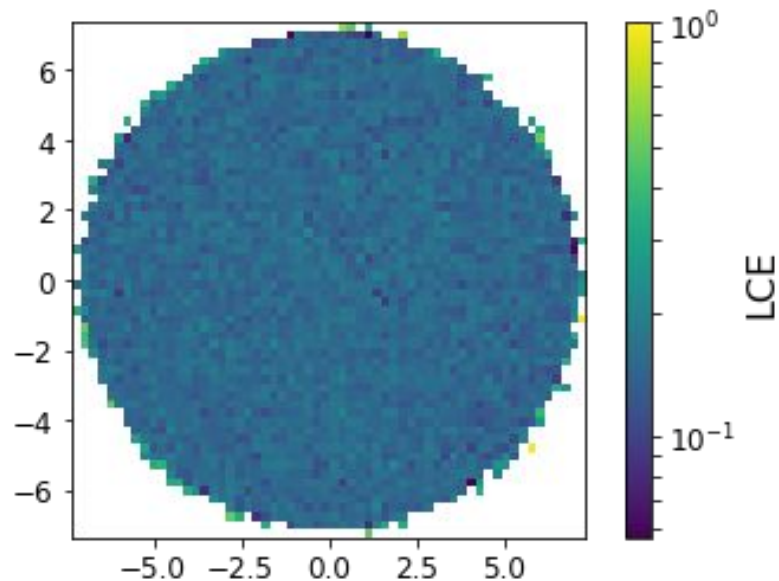

Combined light collection efficiency
Avg: 14.8% With QE: ~4.4%

Phase 1 photon maps (S2)

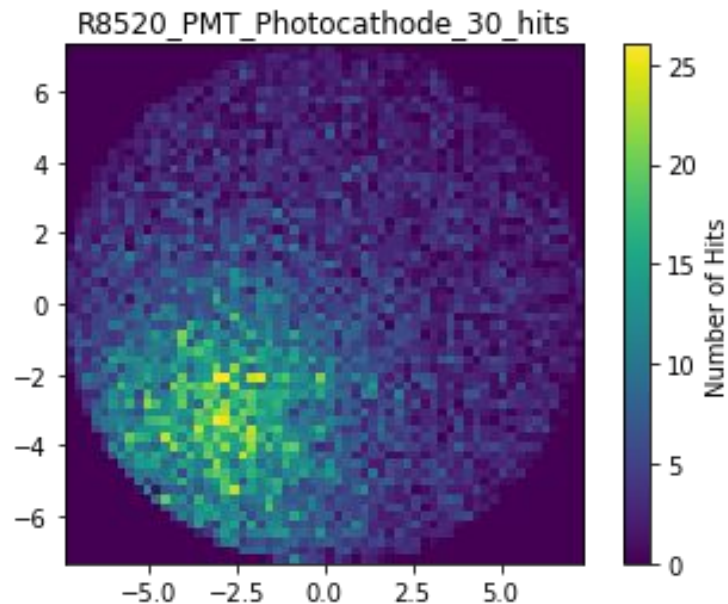

Example of a single PMT

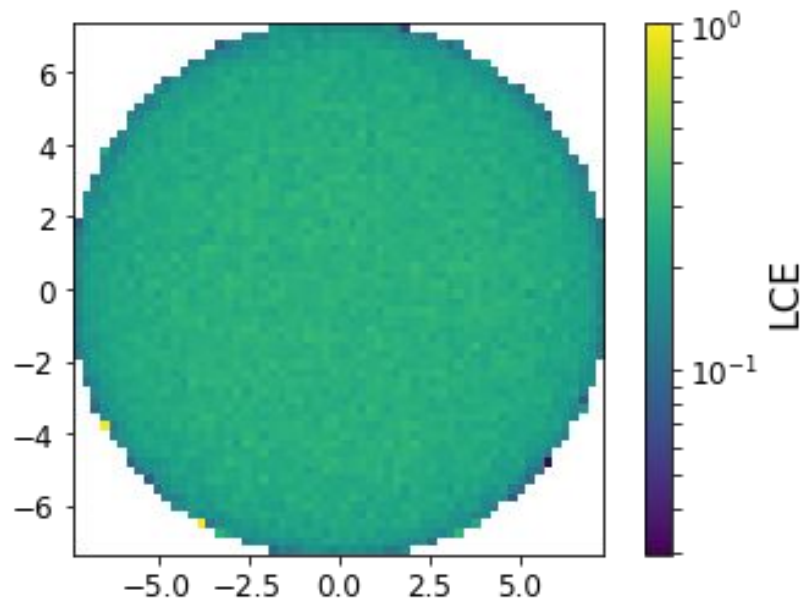

Combined light collection efficiency
Avg: 24.7% With QE: ~7.4%

LCE as a function of depth

S1 LCE over depth

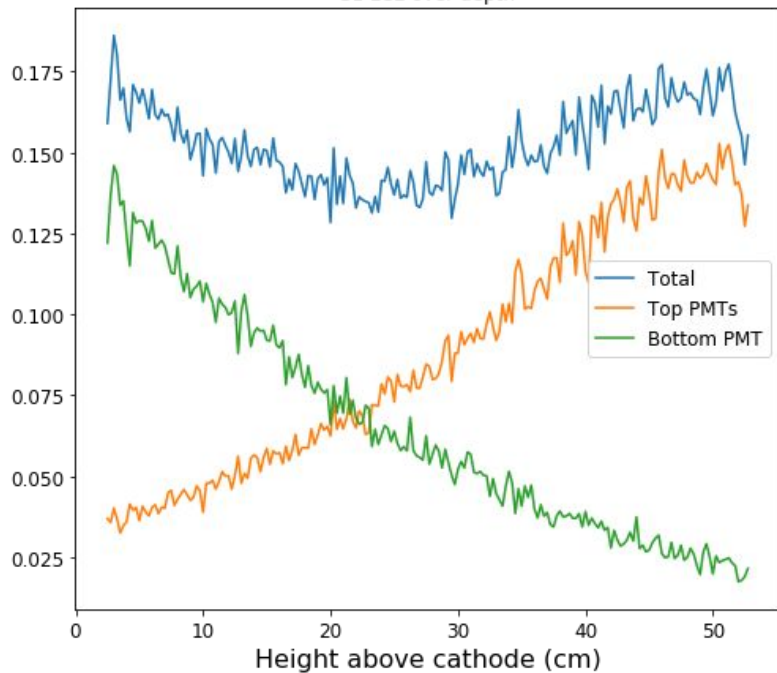

S2 LCE over depth

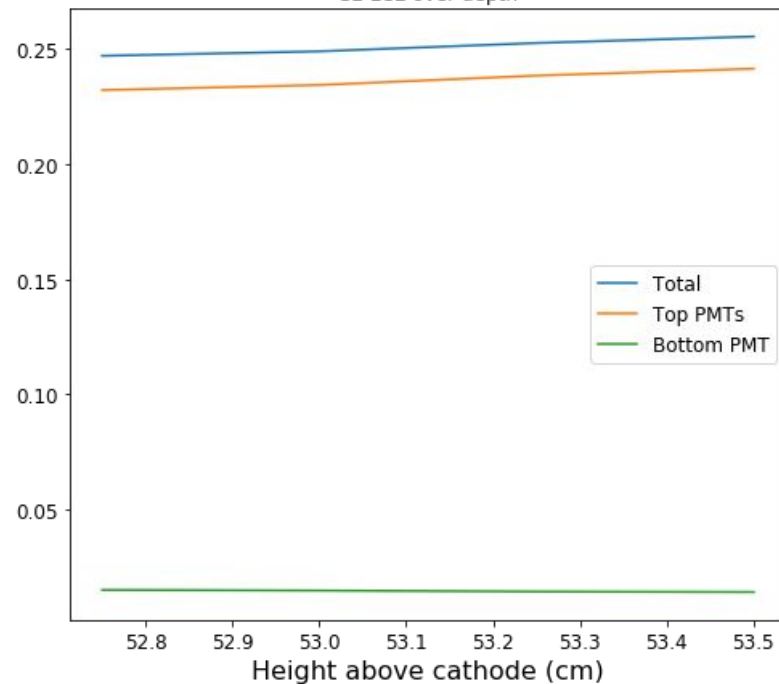

LCE as a function of radius

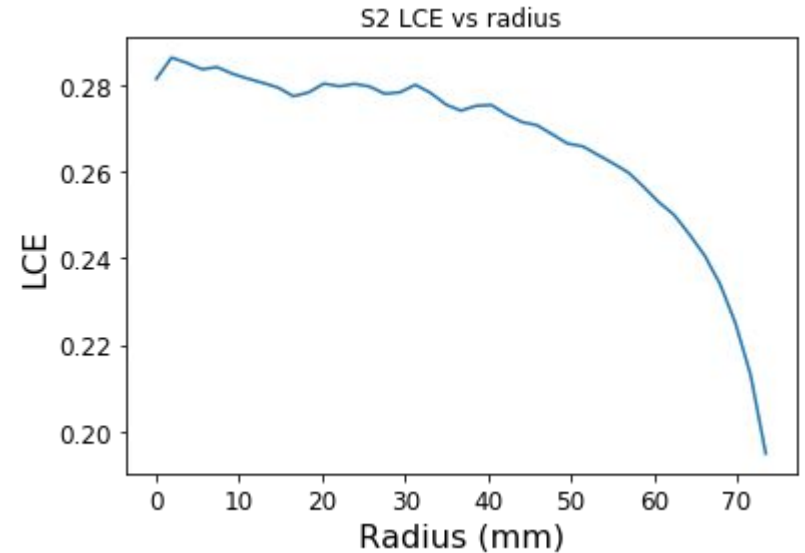
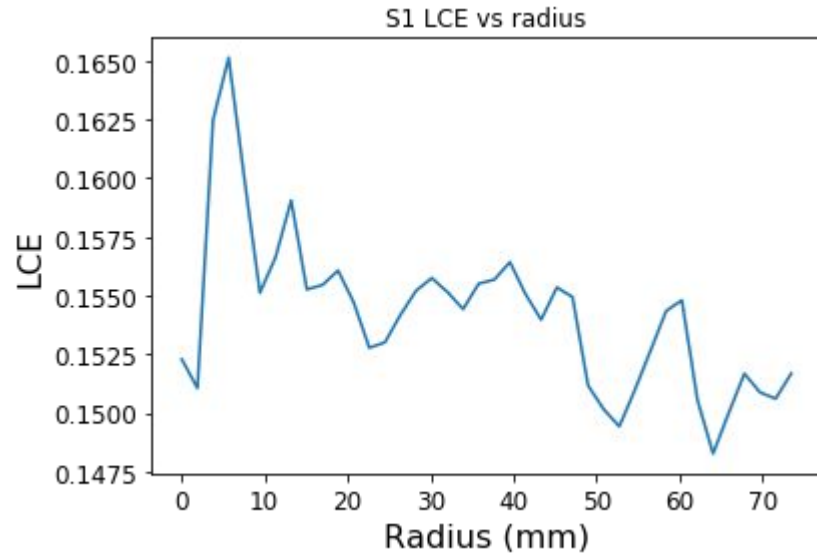

Time maps included

Time maps are needed by BaccMCTruth so needed to be simulated separately.

Shown here for S2 events.

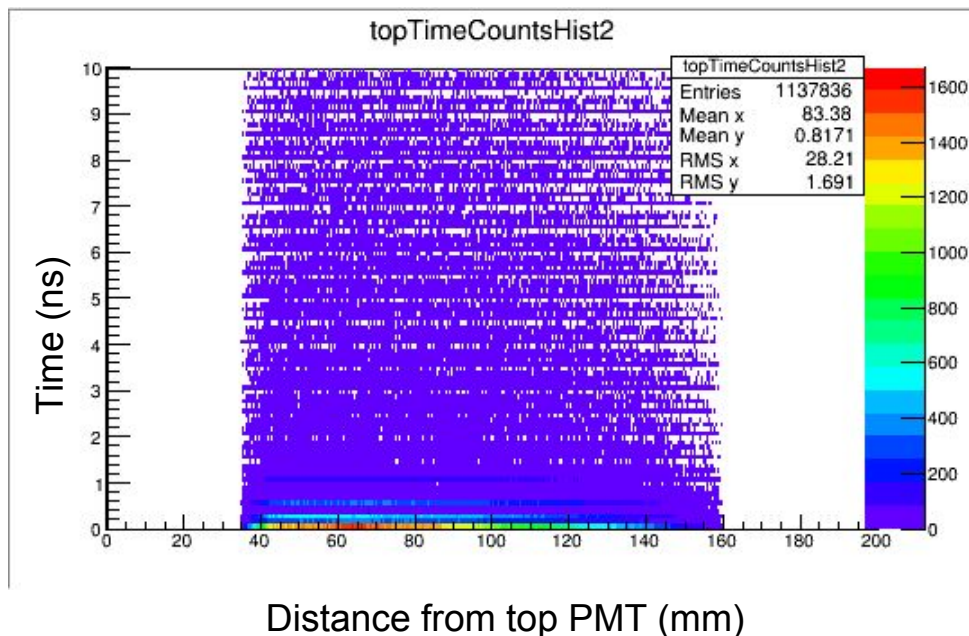

LZ Scale Model

Ready to 3D printing
modifications.

Need 3D printer specs to
adjust minimum thicknesses,
overdraft

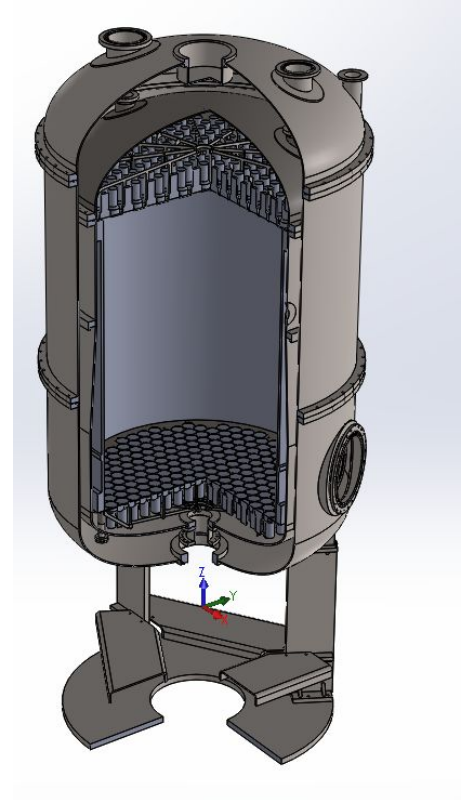
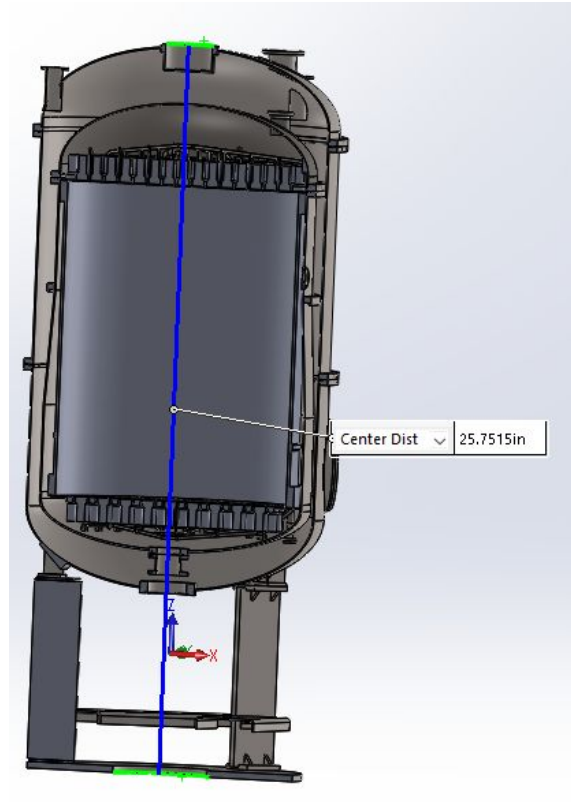

Phase 1 Run 7 analysis

- Progress has been slow
- No quick way to transfer data between SLAC and Izlogin
- Have 8 data files from run 7
- Been looking at noise that occurred while the gas test was running
- Right shows the gas test off case

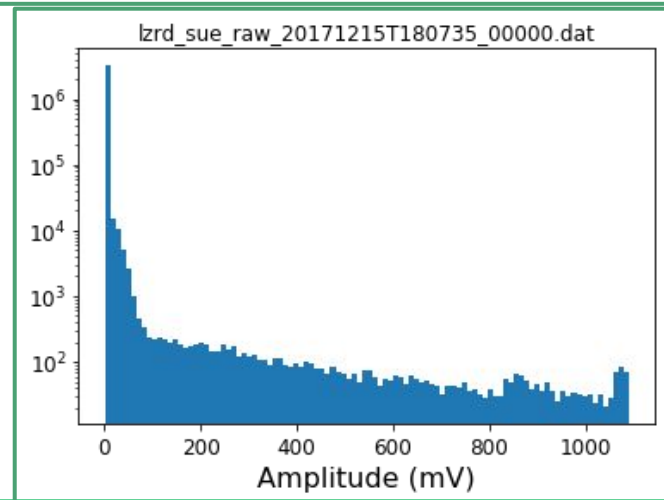
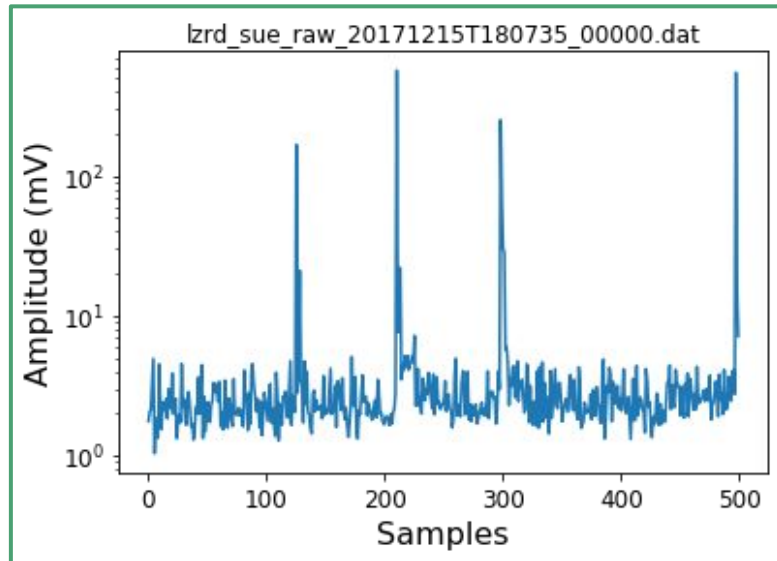

Amplitude Area plot for the two cases

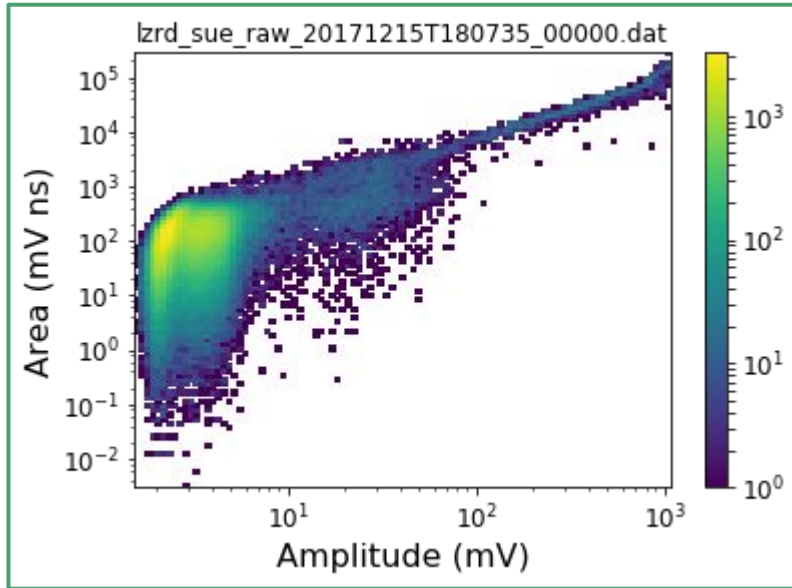

Gas test off

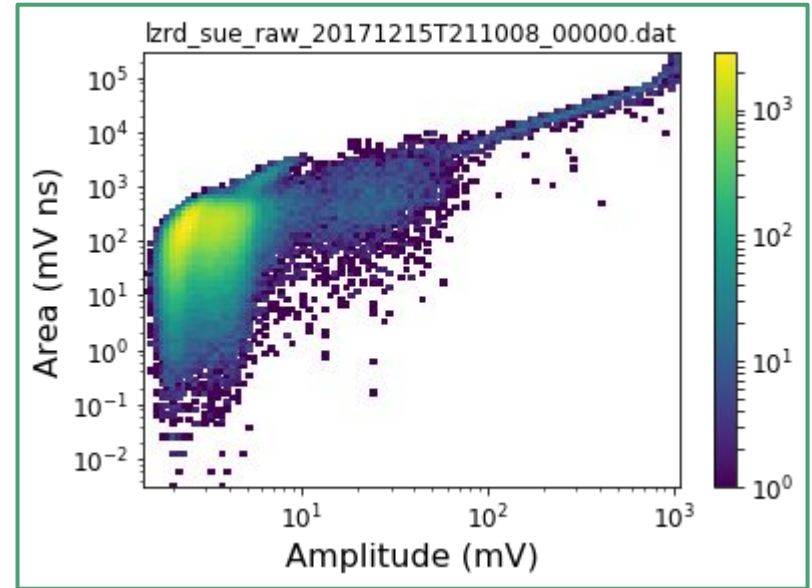

Gas test on

Digitizer noise power

- All fields and PMTs were off
- Only digitizer noise
- See peak at 372 kHz
- Assuming that the data was collected at 250 MHz

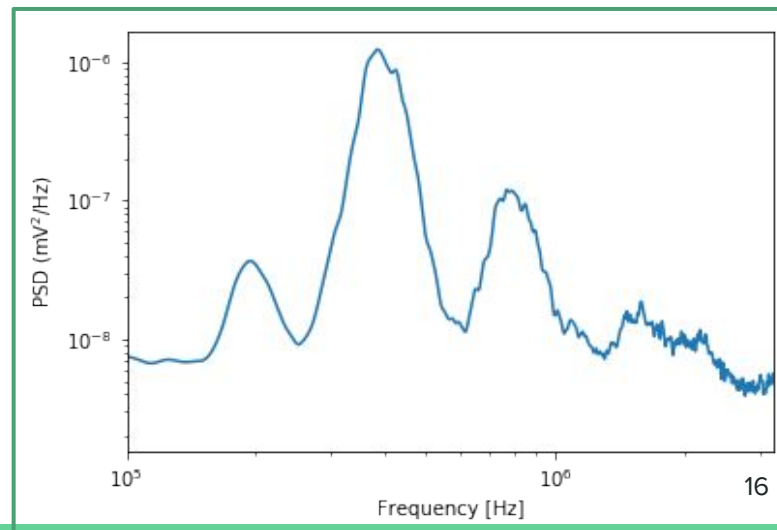
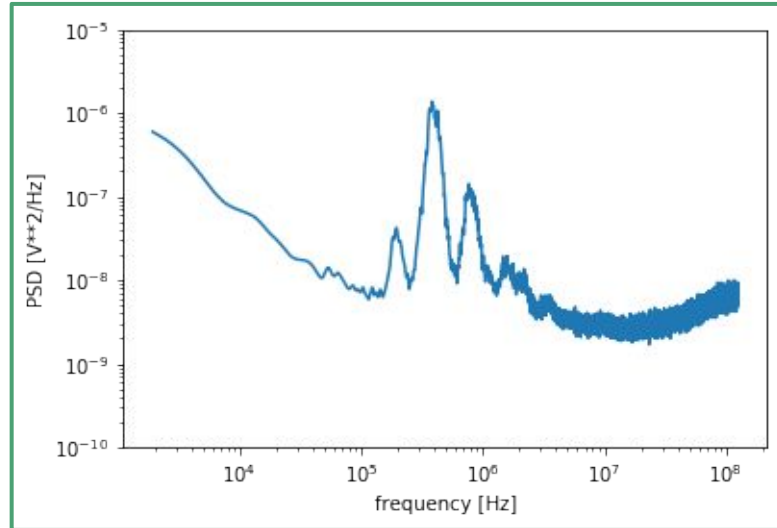

Noise Power at different gas test voltages

- Don't see a significant difference between gas test on and off
- Blue, orange and green are all the same voltage in Phase 1 with different voltages in gas test

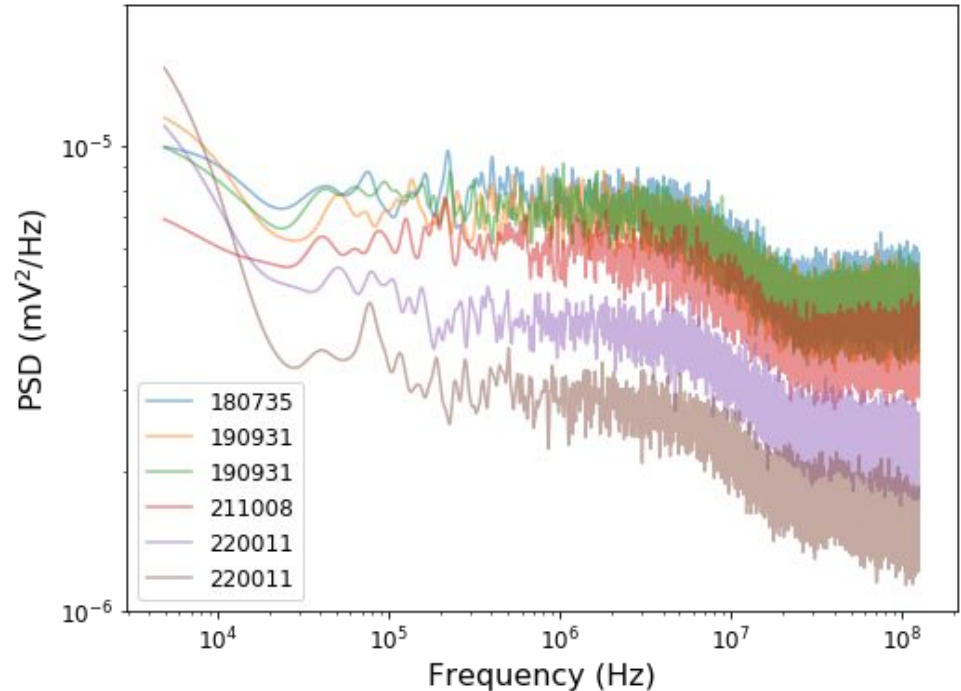

Quantities vs. Field values

- Plots of RMS amplitude and area, and Mean amplitude and area versus power supply voltage for different channels
- Don't see a strong correlation between gas test voltage and RMS and Mean signals

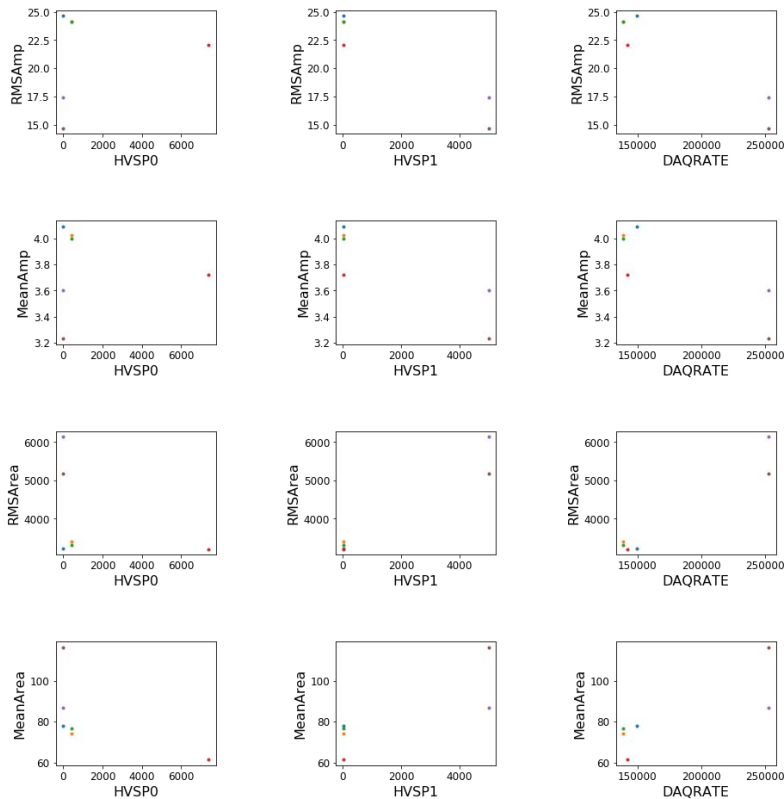

Gas test voltage

P1 Cathode Voltage



Signals over time

- Stars indicate PMT signal mean and rms values
- Blue line is gas test supply voltage
- Purple line is Phase 1 supply voltage

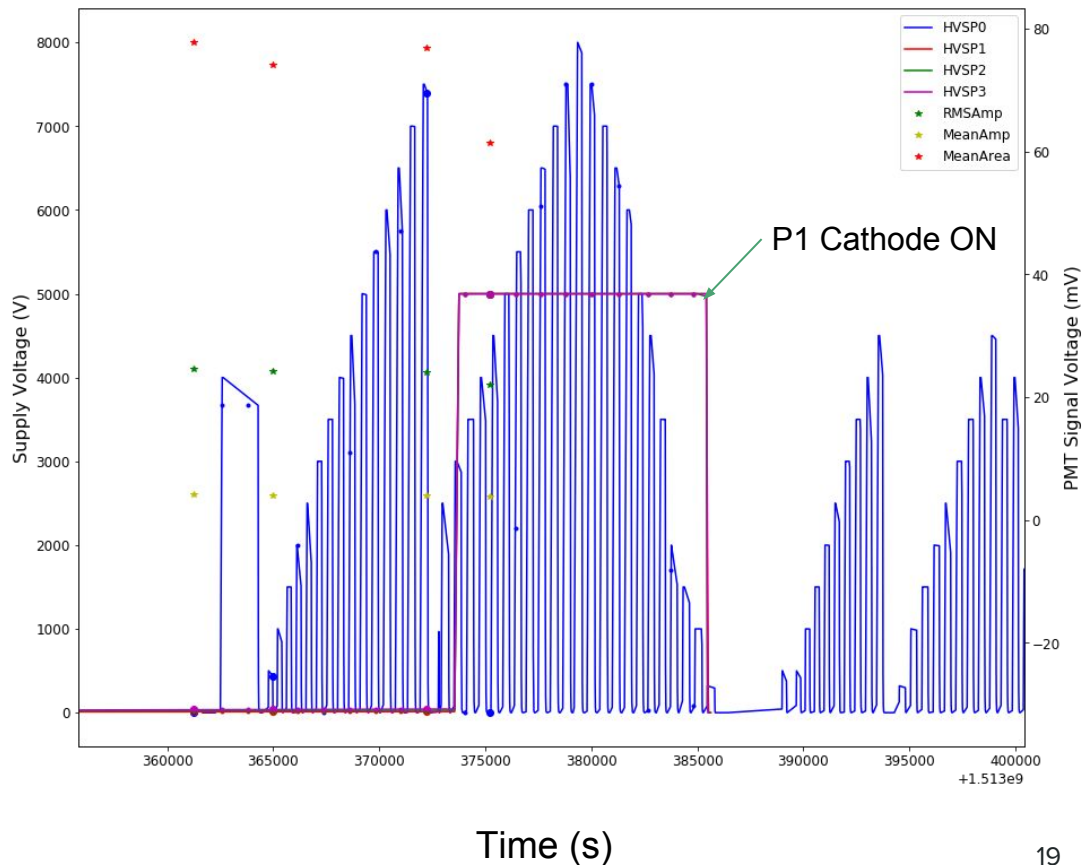

100 T sensitivity projections

- Plan to put spectra into NEST with LUX data
- Want to focus on major contributors to the background
 - Radon
 - Neutrinos
- These are 75% of LZ backgrounds
- Plan to take NEST output and feed into PLR

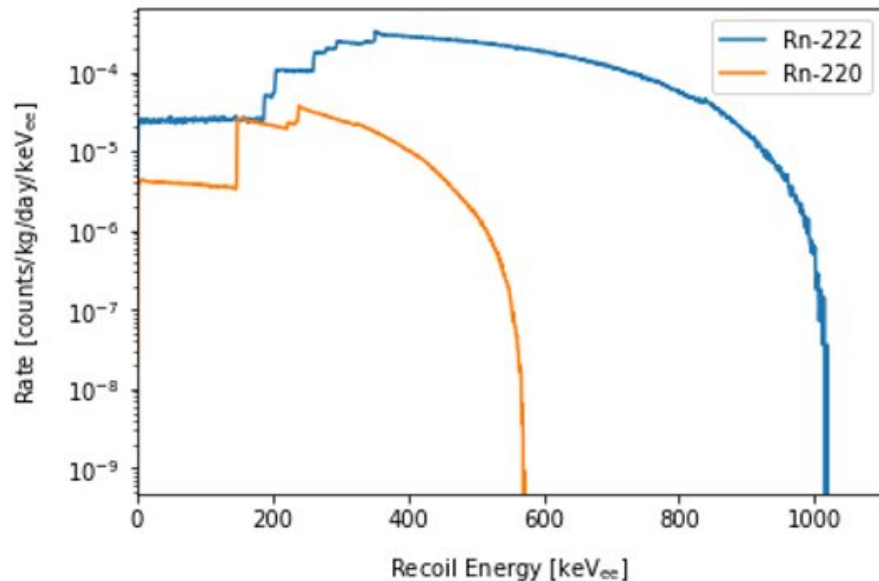

Group calendar

- The calendar is a google calendar which means I think you need a google account to view it
- I dont think there is a good way to automatically sync with outlook (sorry)
- I can add your google accounts but I need your email address

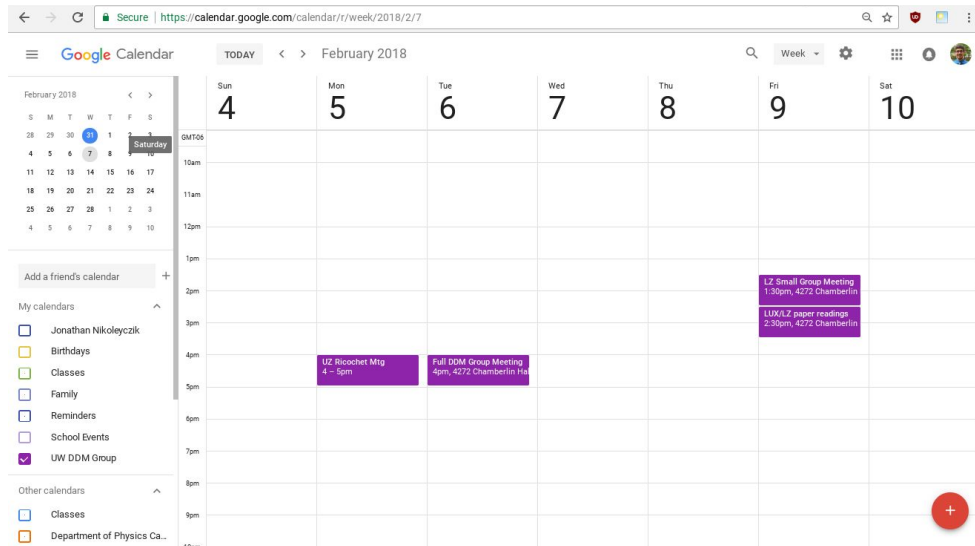

Phase 1 Run 7 Analysis

- Trying to correlate Phase 1 rates and noise with the operation of the gas test
- Divided amplitude area plot into different populations
- The rate is more correlated with the total power supply voltage than with the gas test alone
- See no significant noise power difference between gas test on and off

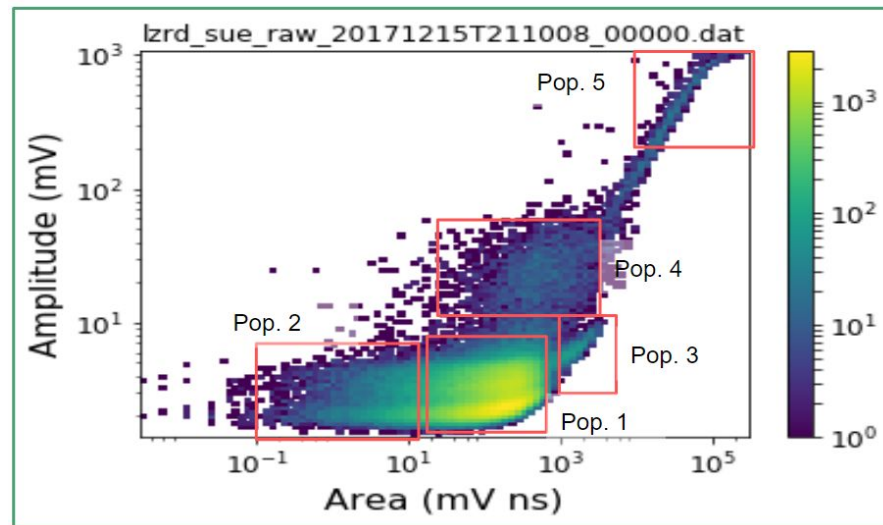

Population rates over time

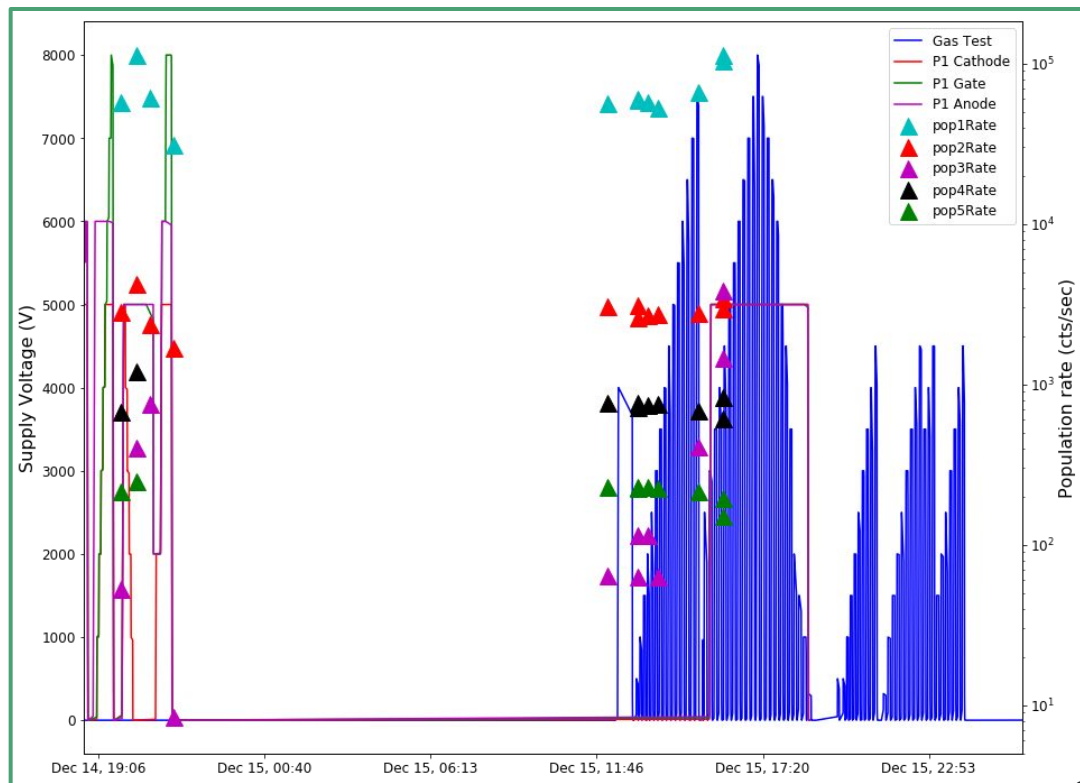
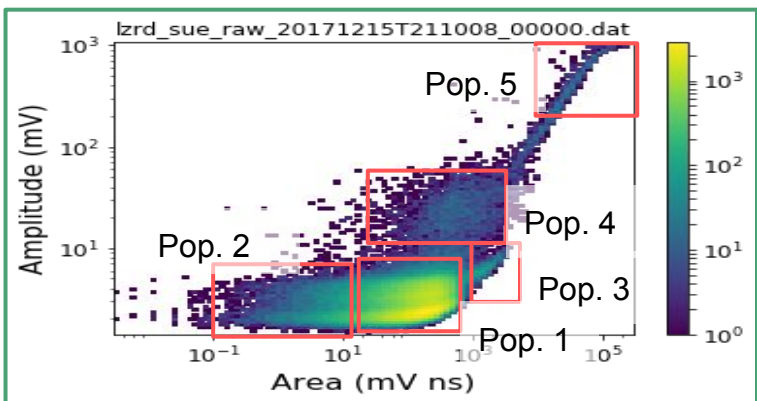

DAQ rate vs. Gas test voltage

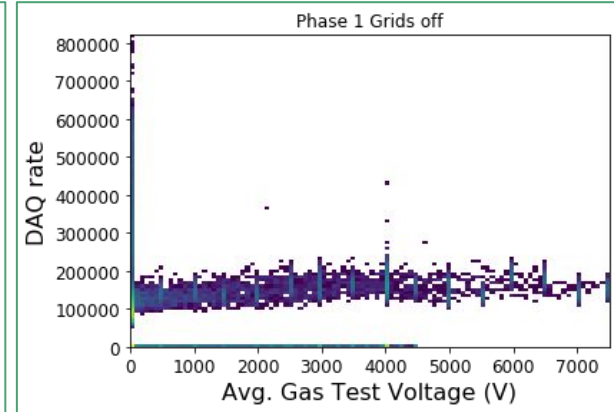
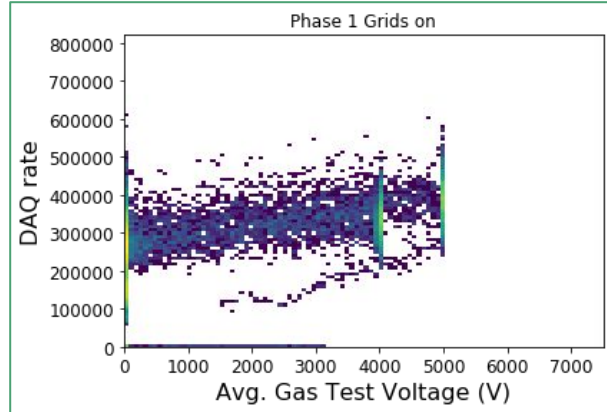
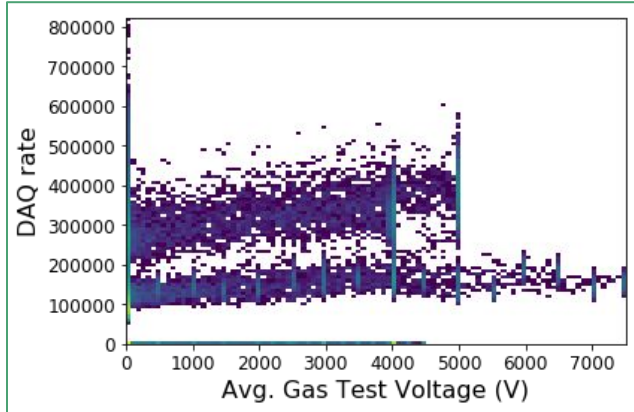

Possibly some correlation between gas test voltage and rate but only in the phase 1 grids on case

DAQ rate vs. PS voltage

- Combines physical expected rate increases (P1 grids on) with gas test voltage increases
- Color corresponds to number of samples at that point
- Outliers at low voltage are older data sets (gas only tests?)

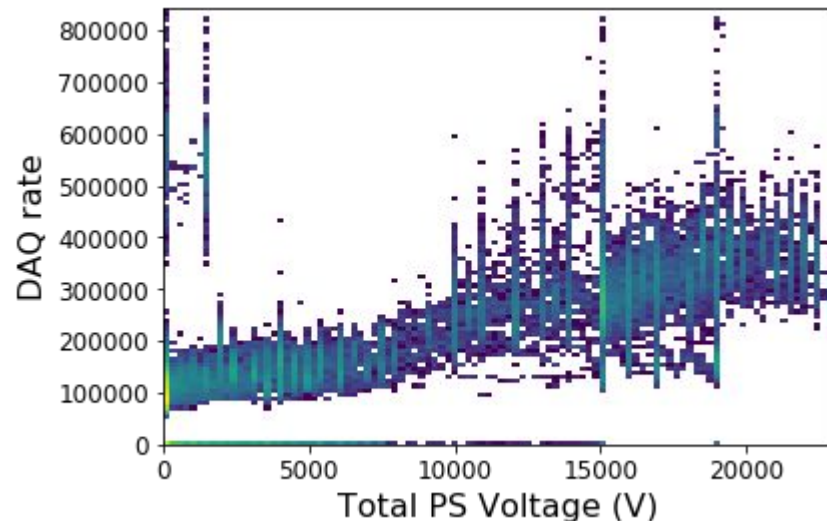

PSD of waveforms PMT off

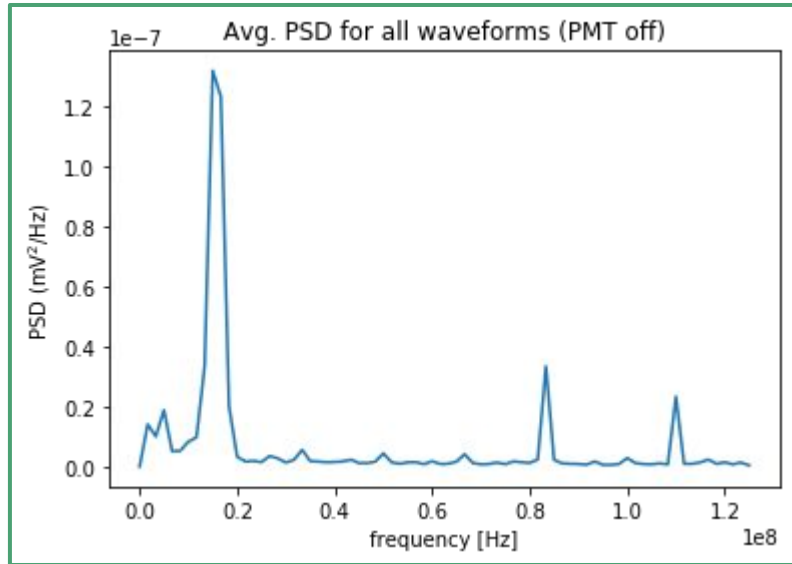

Averaging over all waveforms
Peaks at 150, 830, and 1100 MHz

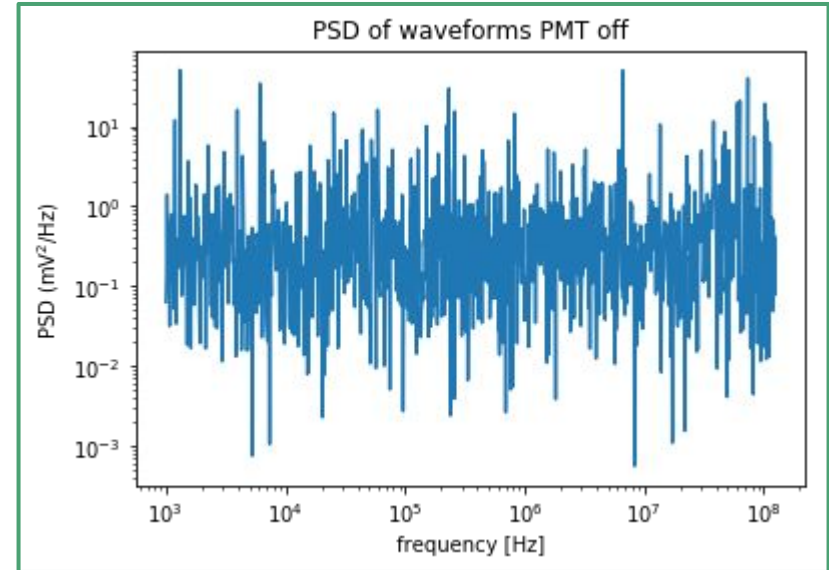

Combining waveforms

PSD waveforms PMT on

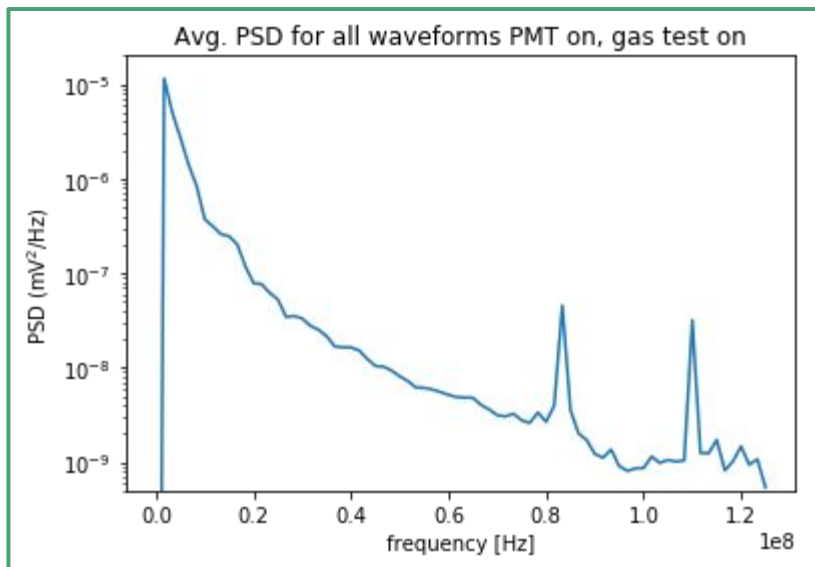

Averaging over all waveforms
Peaks at 830, and 1100 MHz
Note the change to log scale.
This is $1/f^{2.4}$ noise

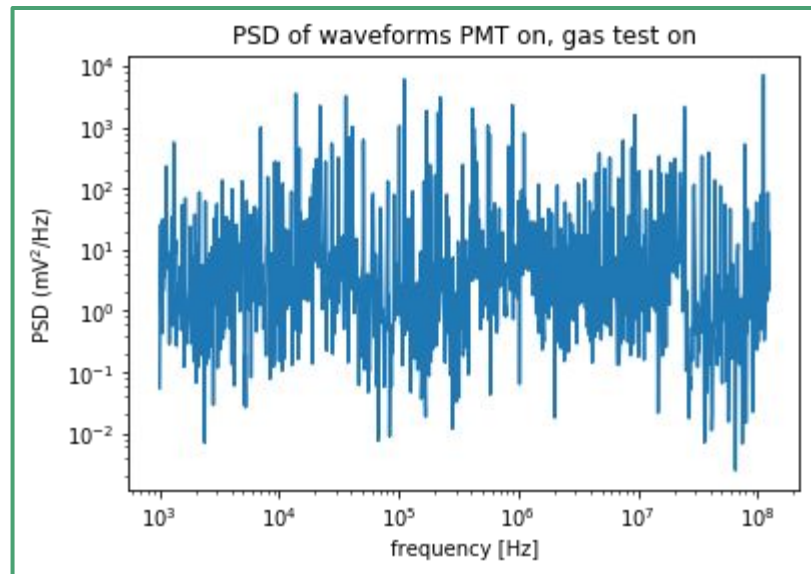

Combining waveforms

Gas test on and off has no noticeable effect on
PSD from 10³ to 10⁸ Hz

Gas test on vs off

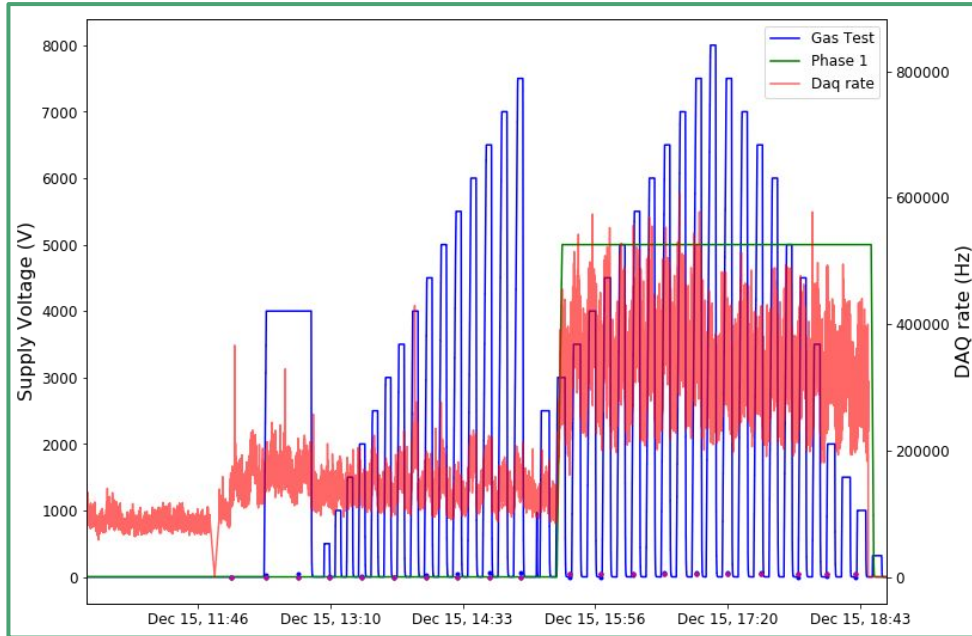

Histogram of the data shown on the left

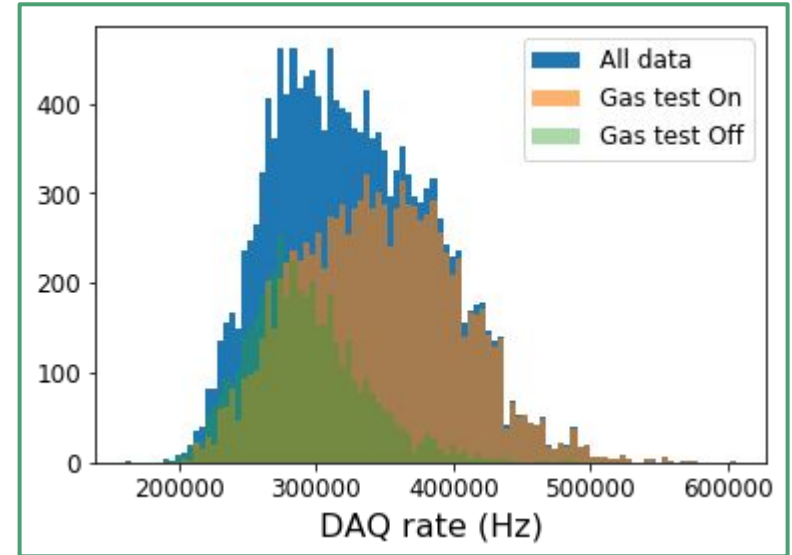

Rates and voltages over time

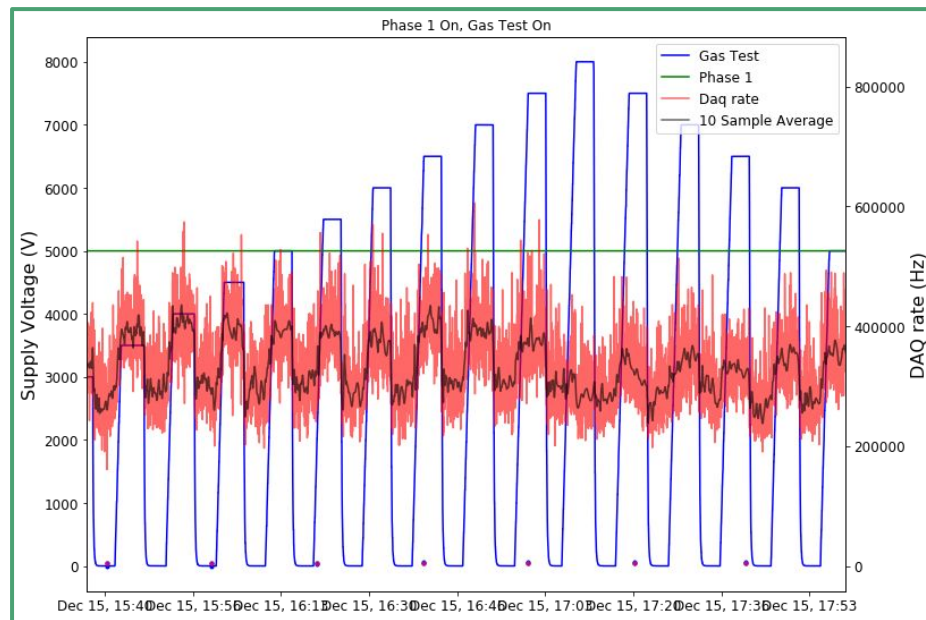
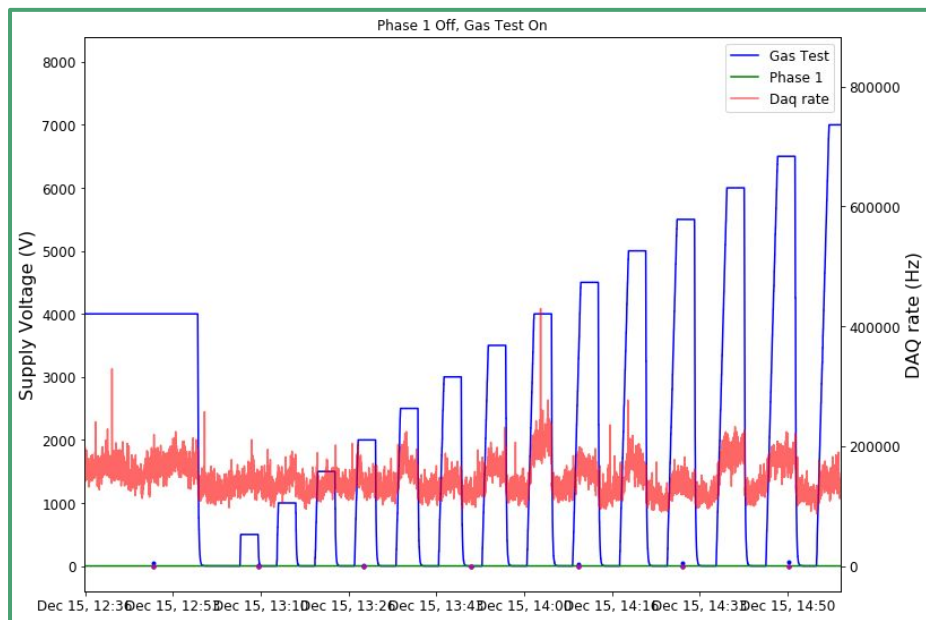

See clear increase in DAQ rate as gas test voltage ramps up increase. DAQ rate increases by $\sim 50\%$

Rates and voltages over time

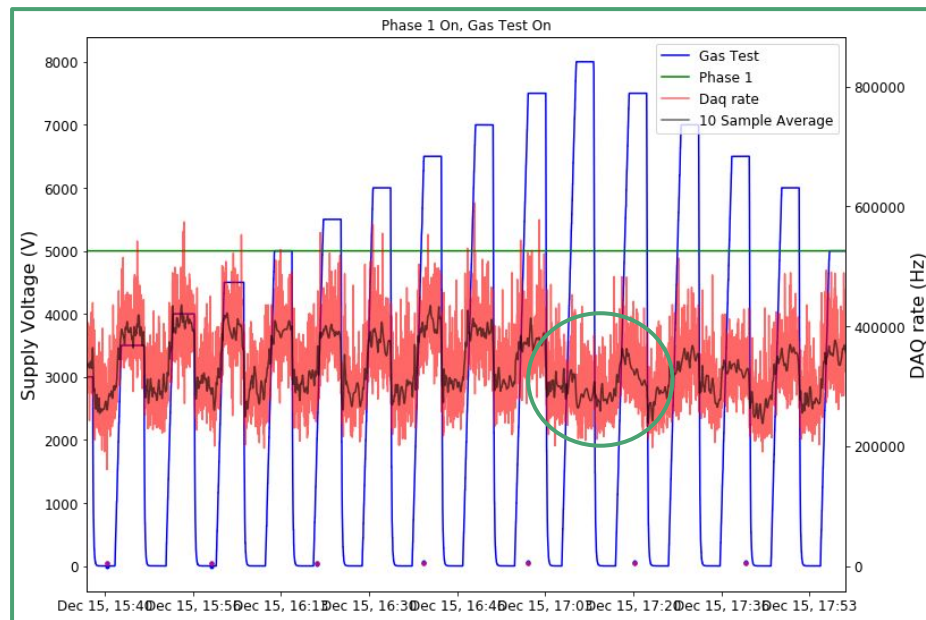
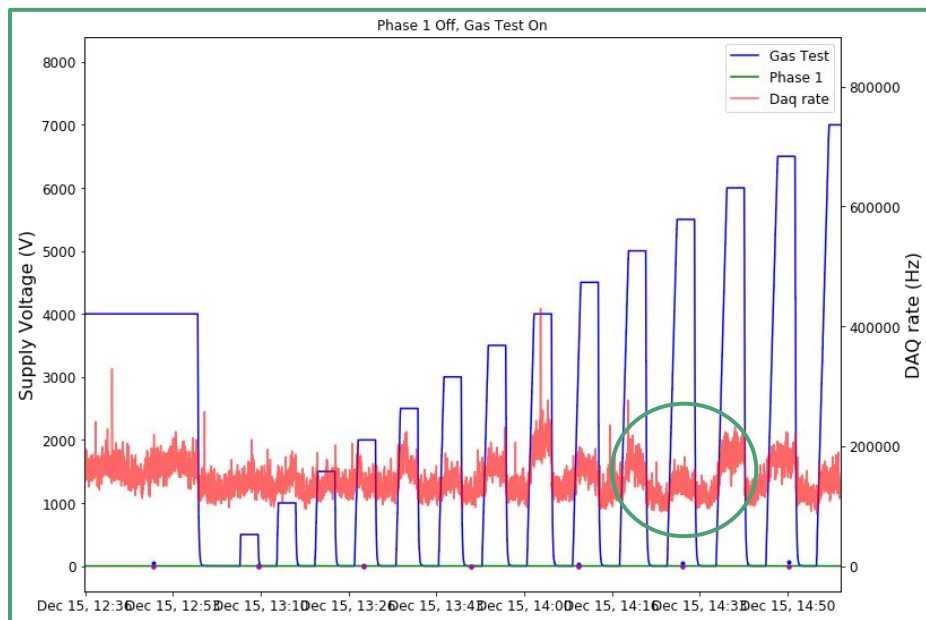

Not all gas test voltage increases correspond to DAQ rate increases

Rates and voltages over time

See variability in pop.
3 rate of up to an
order of magnitude

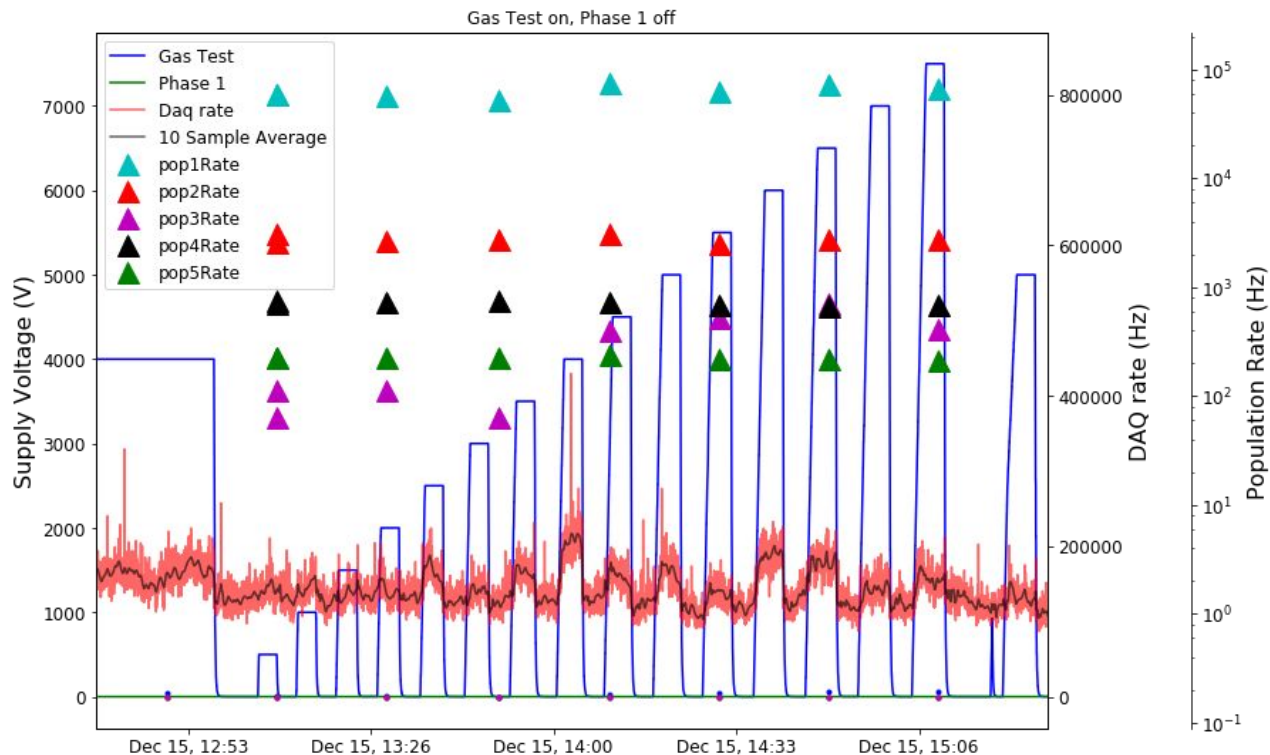
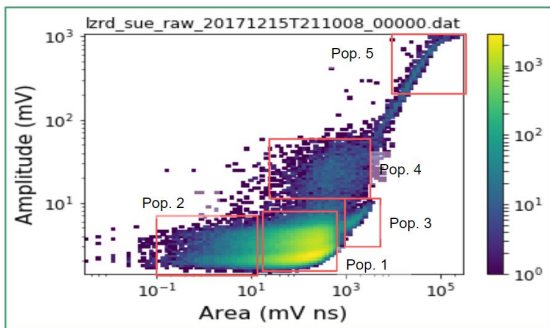

Rates versus voltage

- This is only data when the phase 1 grids are off
- We do see a correlation between the gas test voltage and the population 3 rate (high area, low amplitude)

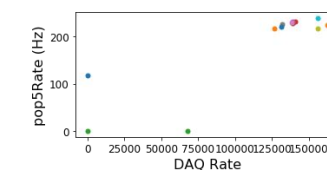
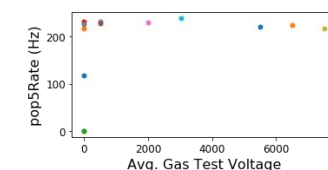
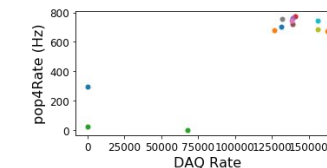
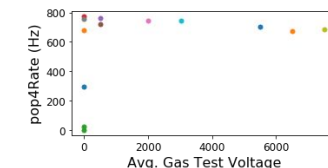
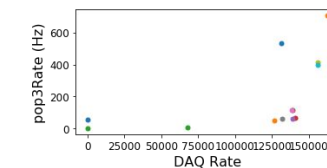
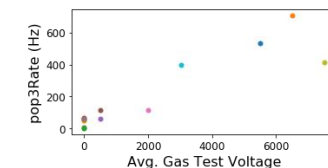
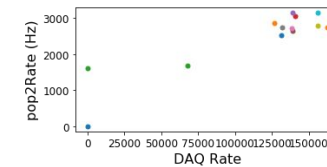
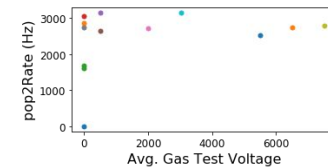
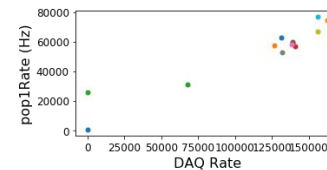
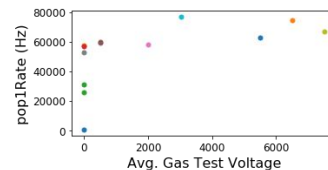
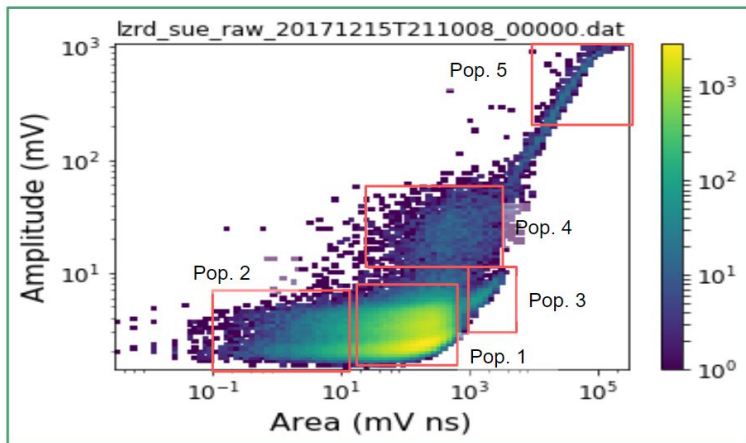

Other updates

- LZ Cables QA
 - Need to have a schedule for cable procurement and assembly by tomorrow
 - Havent heard back from Bob or Jeff about these dates
- LUX 100 Ton projections
 - Plan on using libNEST for a generic detector rather than being LZ specific
 - Means we only need energy spectra
 - Have to wait for limit code (Quentin) and updated libNEST (Matthew)
 - Can just use flat background energy spectrum to avoid using LZ sensitivity results

System Test Analysis

- Looking at reduced Run 7 data
 - It's in a different form than I was expecting (DER output format, not LZAP output format)
 - Really only gives waveforms and their start and end time
 - Hoping tomorrow's analysis meeting will clear this up
- Phase 1 optical maps are implemented in BaccMCTruth
 - Works for both Phase 1 and LZ
 - Haven't pushed to git as the optical map file is hard coded to my directory
 - Where should it be stored? PDSF? CVMFS?

LUX 100 T projections update

- ER and NR band data as a function of voltage are progressing
- We will stick with a flat ER background and Neutrinos as the dominant NR background
 - There was some discussion of including low energy lines in the ER spectrum but this would only make the result harder to compare to other experiments and in real WIMP search data a line would get spread out anyway
- Waiting on Quentin to send his sensitivity code on git
 - Need lux git account?