

Collisions between Transversely Polarized Protons with Forward π^0 Production.

(Transversity Results From STAR)

Steve Heppelmann

Penn State University

For the STAR Collaboration



For the STAR Collaboration



Outline

- Importance of High Energy Transverse Spin Measurement (Historical and Present).
- The STAR (RHIC) Environment for Forward Spin Physics.
- Forward Measurements by STAR.
- Future Forward Physics at STAR.
- Summary.



At large energy, the quark scattering cross section does not depend on nor does it change the transverse spin of a quark.

However: The quark spin can be correlated with other **initial state variables** or **final state variables** that influence the observable momentum (x_F, p_T) distributions of final state hadrons.

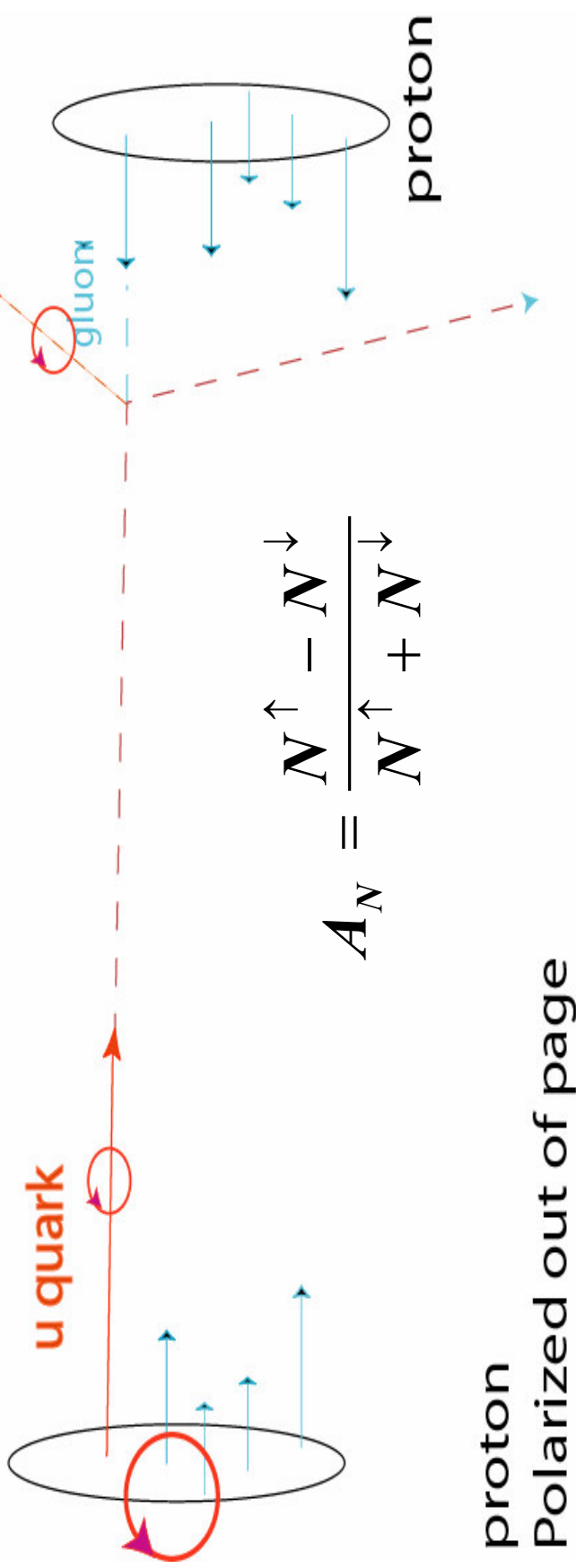

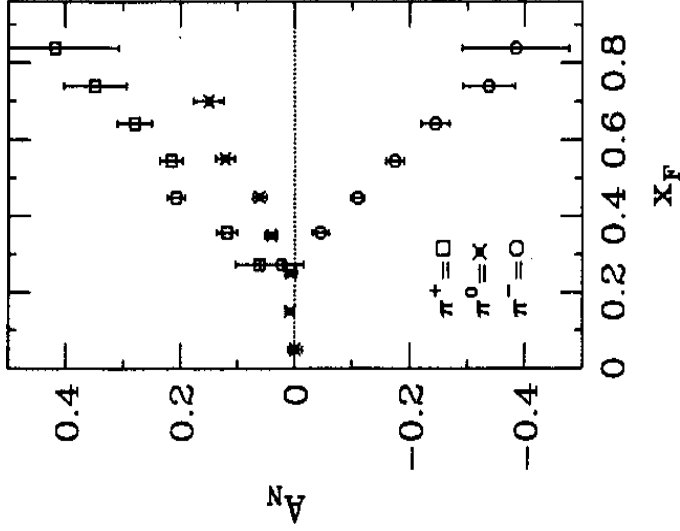

The intuitive message:

- 1) A transverse proton which interacts at large x_f consists of a leading quark (u) for π^+ , π^0 , (d) for π^-
- 2) The leading quark carries much of the transverse spin of the proton.
- 3) Because the quark level single spin asymmetry for scattering of transversely polarized quarks is very small at high energy, the measured asymmetry comes from features of the scattering process not evident in leading twist perturbative QCD with collinear partons.

4) This is interesting. Models involve things like

- Transverse parton distributions (Orbital angular momentum).
- Spin dependent fragmentation (Collins Effect).
- Higher twist calculations.



π^0 - E704, PLB261 (1991) 201.

π^{\pm} - E704, PLB264 (1991) 462.

$\sqrt{s}=20$ GeV, $p_T=0.5-2.0$ GeV/c:

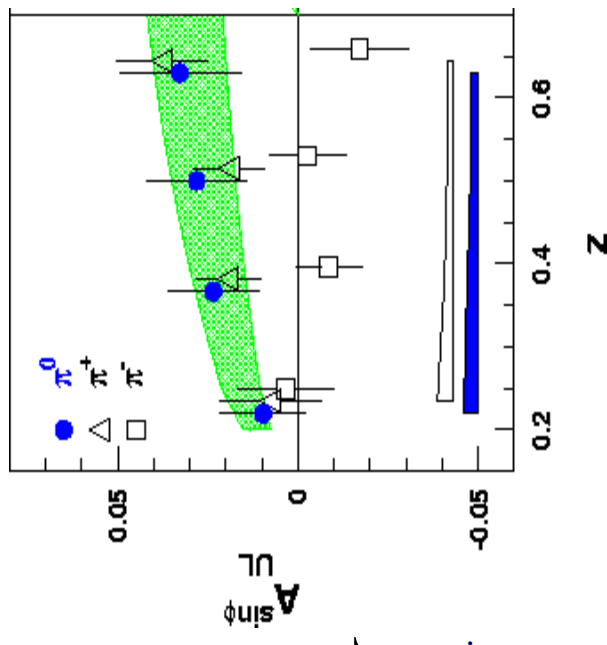

◻ HERMES Collab., PRD64 (2001) 097101.

◻ HERMES Collab., PLB 535 (2002) 85.

◻ HERMES Collab., PRL 84 (2000) 4047.



Brookhaven National Lab

STAR Experiment

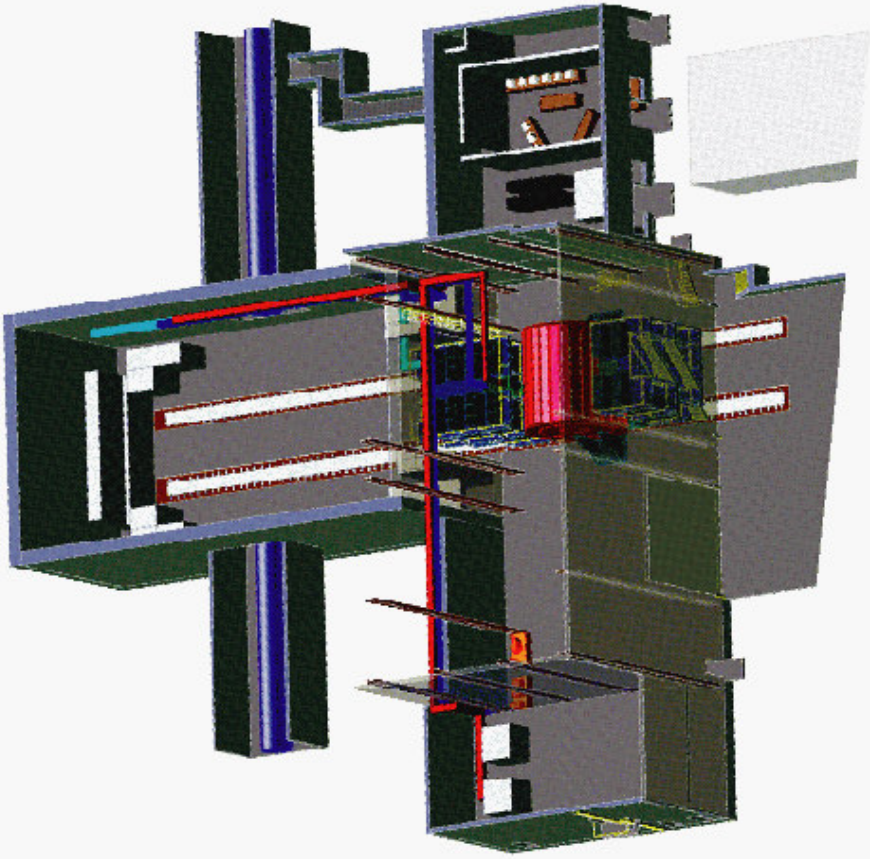

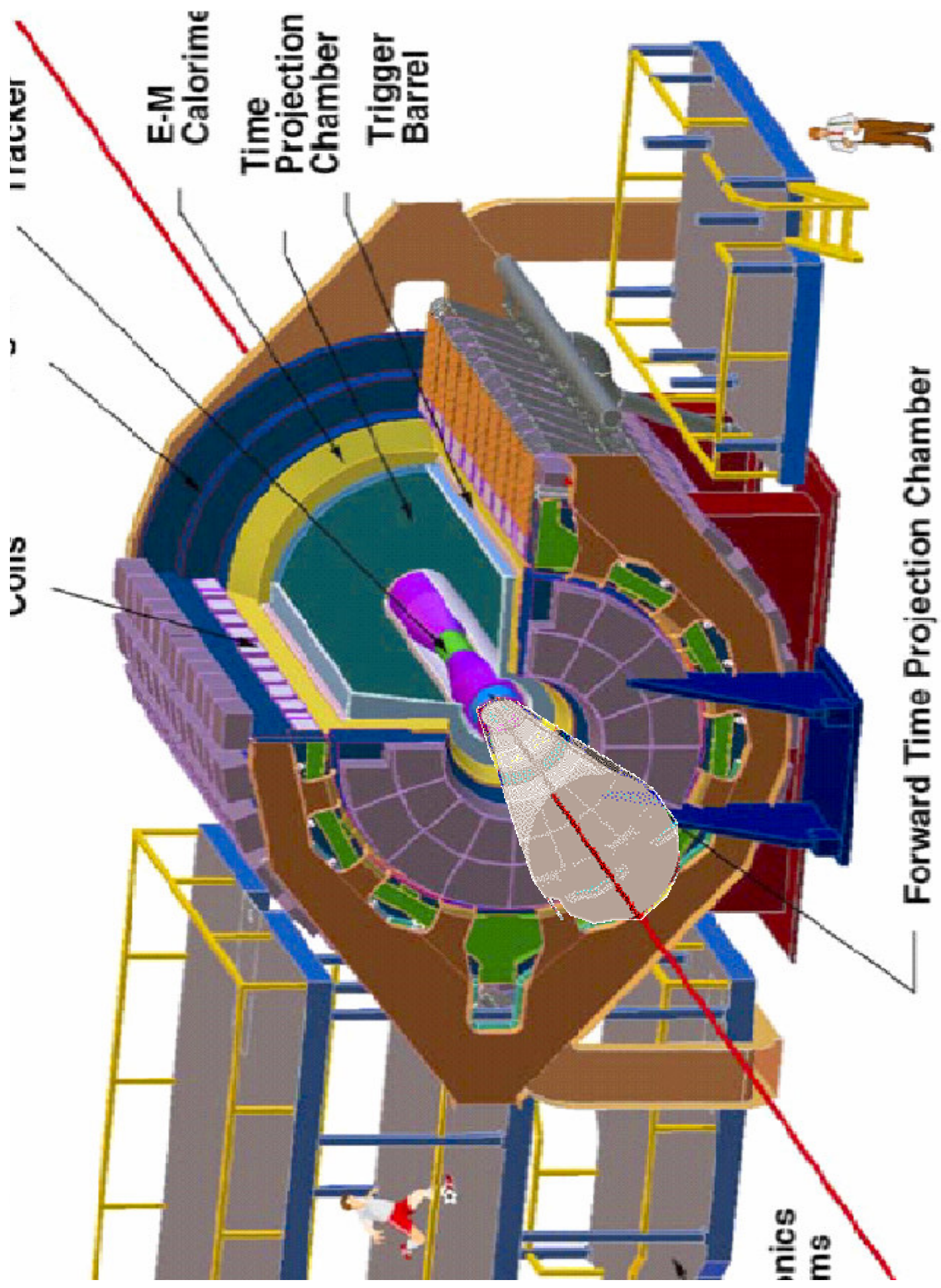

STAR Forward Calorimetry

Recent History and Plans

- Prototype FPD Proposal Dec 2000
 - Approved March 2001
 - Run 2 polarized proton data (published 2004 spin asymmetry and cross section)
- FPD proposal June 2002
 - Review July 2002
 - Run 3 data pp dAu (Preliminary A_n Results)
- FMS Proposal Submitted Jan 2005.
 - Near full Forward EM Coverage. (hep-ex/0502040).

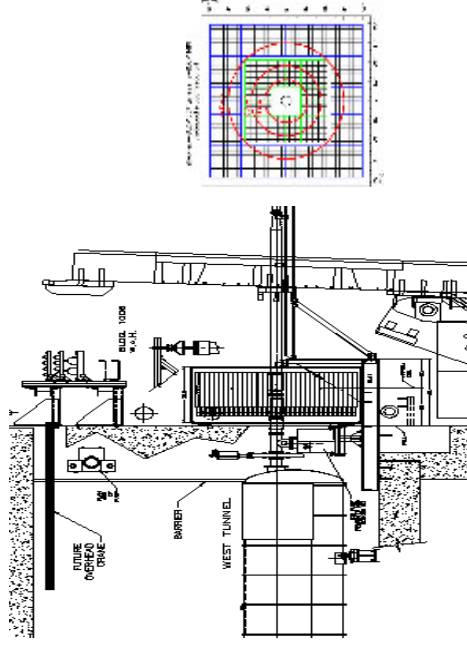
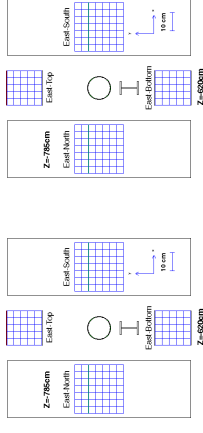
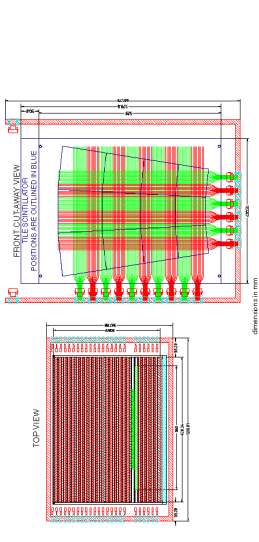

Run 2 FPD Apparatus (East of IR)

- 3 4x4 PB Glass Arrays (3.8x3.8 cm) (Top/Bottom/South)
- 1 Prototype EMC Endcap (North)
- 3x4 PB scintillator stack (North)
- Shower Max x/y strips Scintillator Strip Array (0.37 cm strip width)

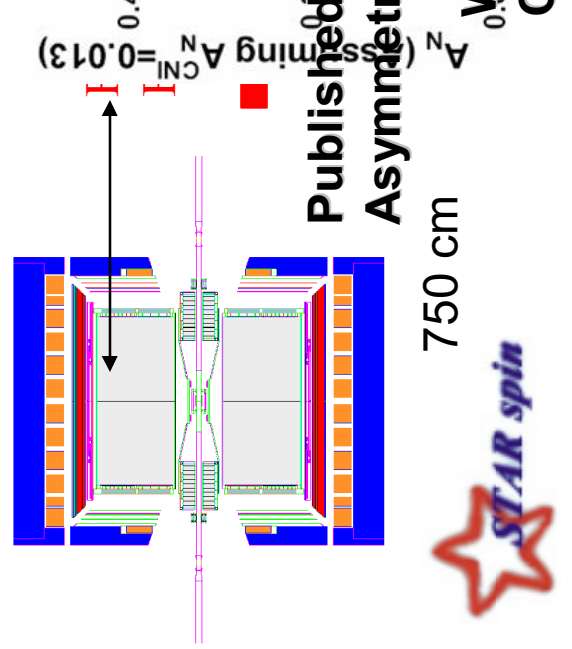
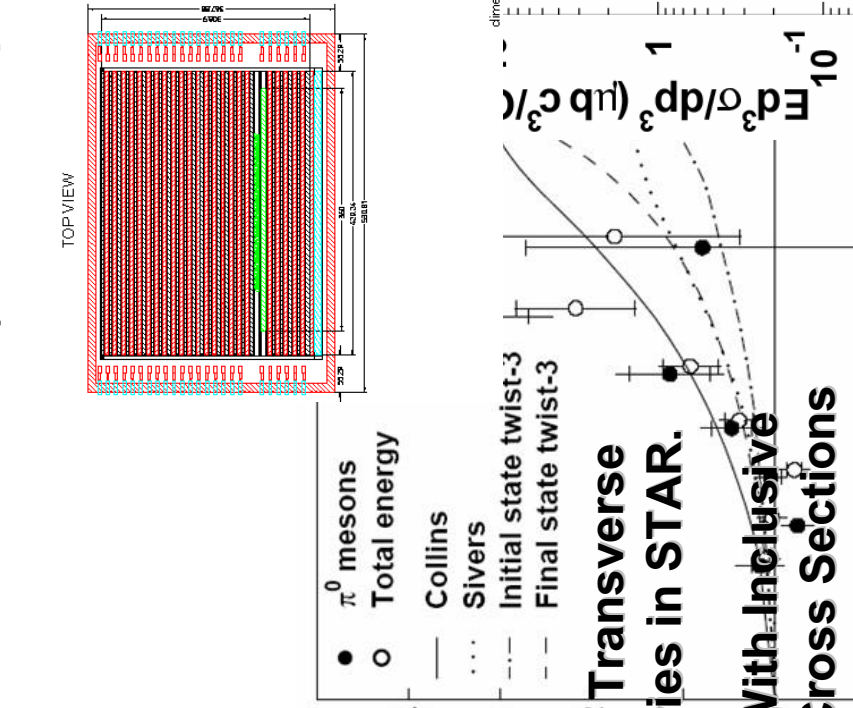
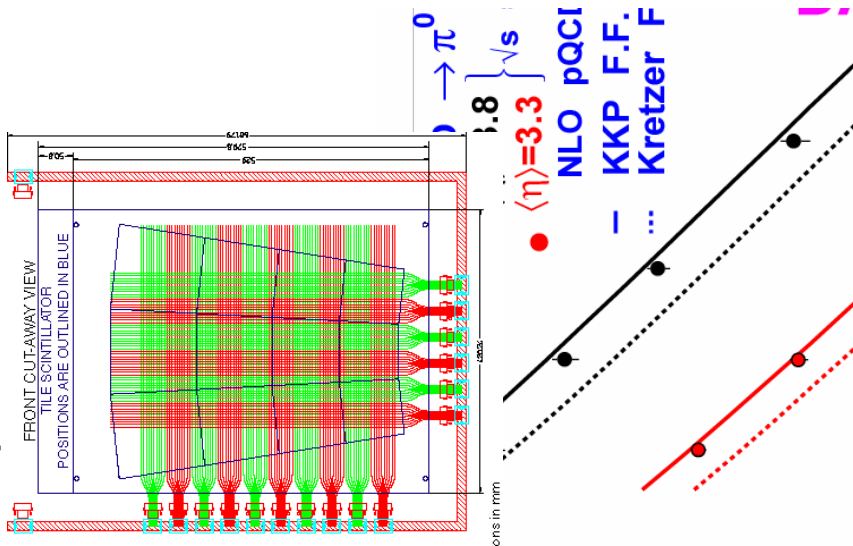
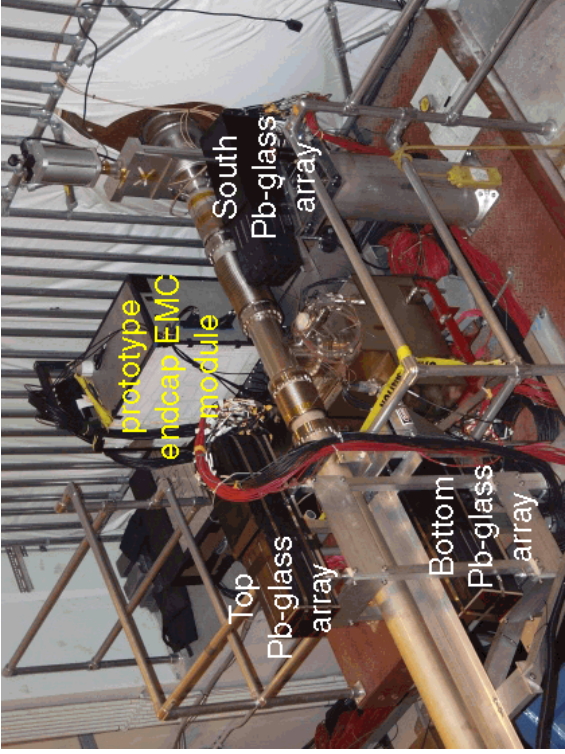

Current FPD Detector

- **Both** East and West of Interaction region we have:
 - 2 5x5 arrays of Pb Glass (up/down)
 - 2 7x7 arrays of Pb Glass (North/South)

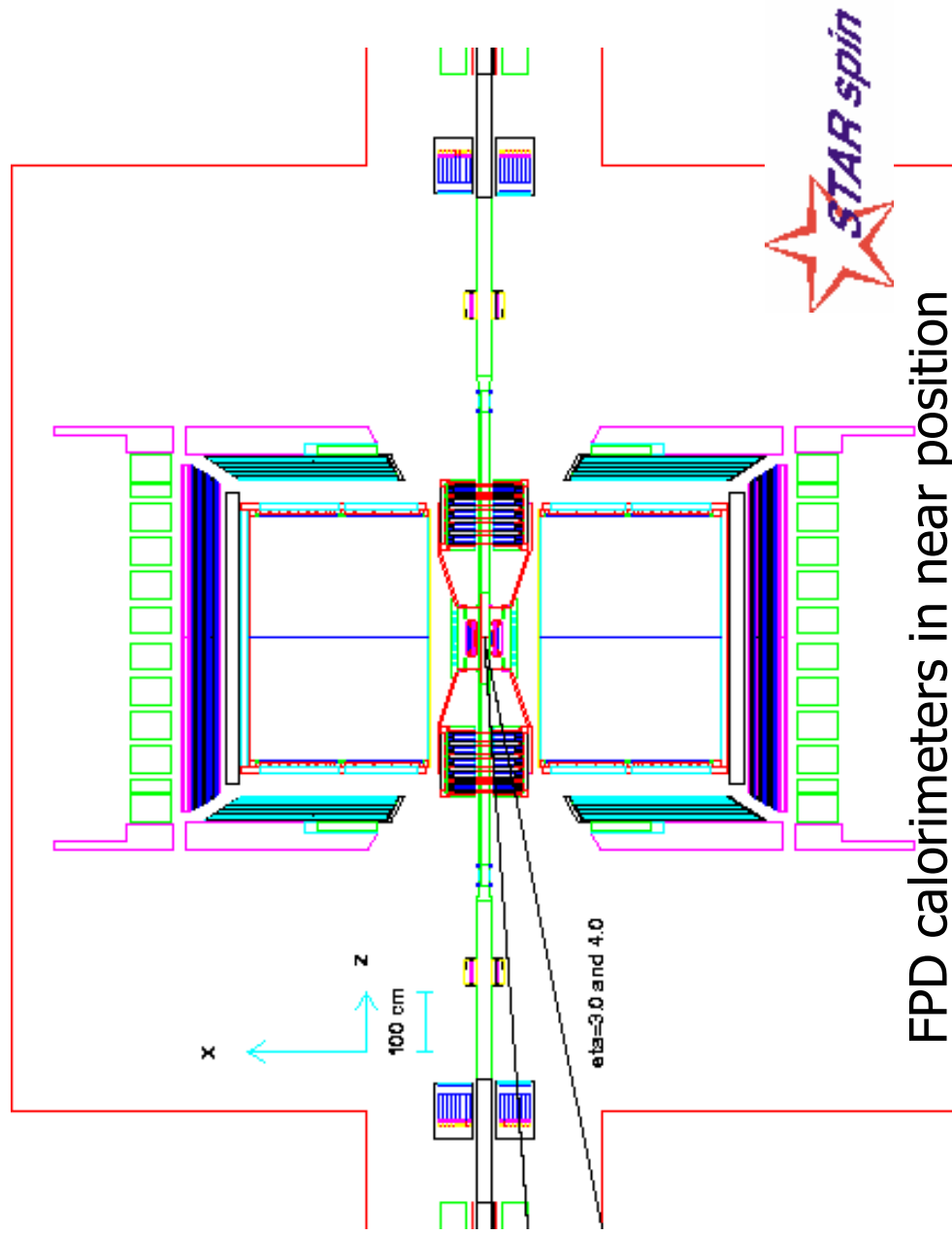
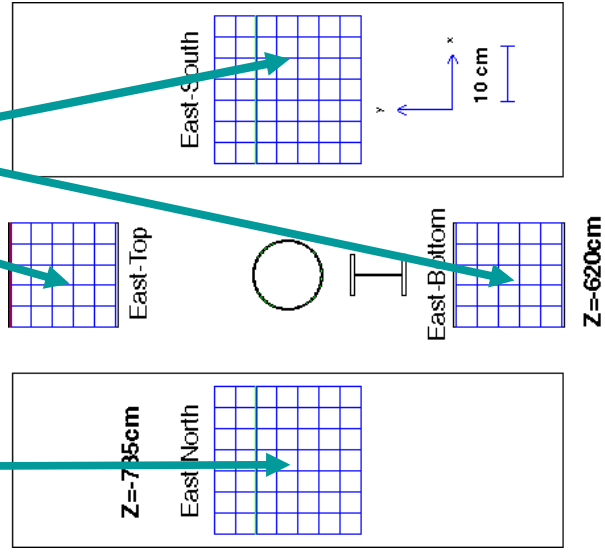
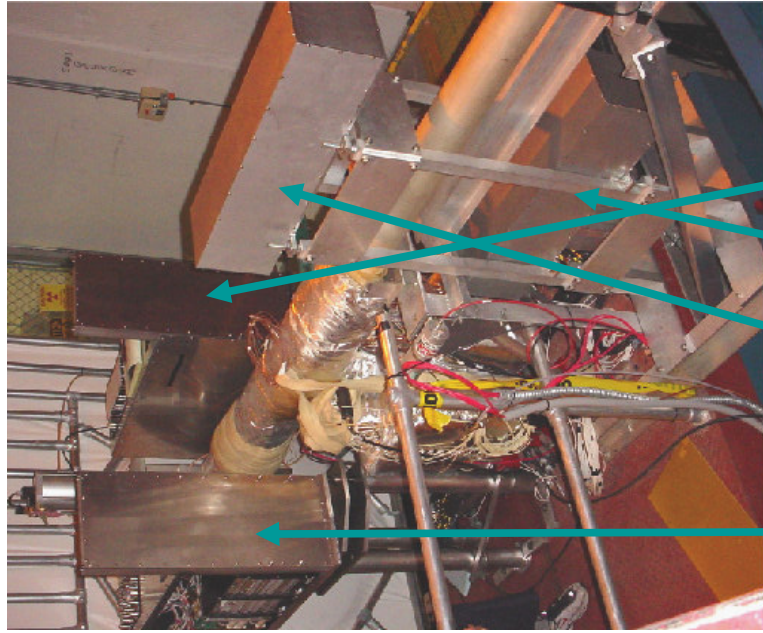

STAR -FPD Preliminary Cross Sections

$E \frac{d^3\sigma}{dp^3} (\mu\text{b c}^3/\text{GeV}^2)$

Similar to ISR analysis
J. Singh, et al Nucl. Phys.
B140 (1978) 189.

$$E \frac{d^3\sigma}{dp^3} \propto |1 - x_F|^N P_T^B$$

$N \approx 5$
 $B \approx 6$

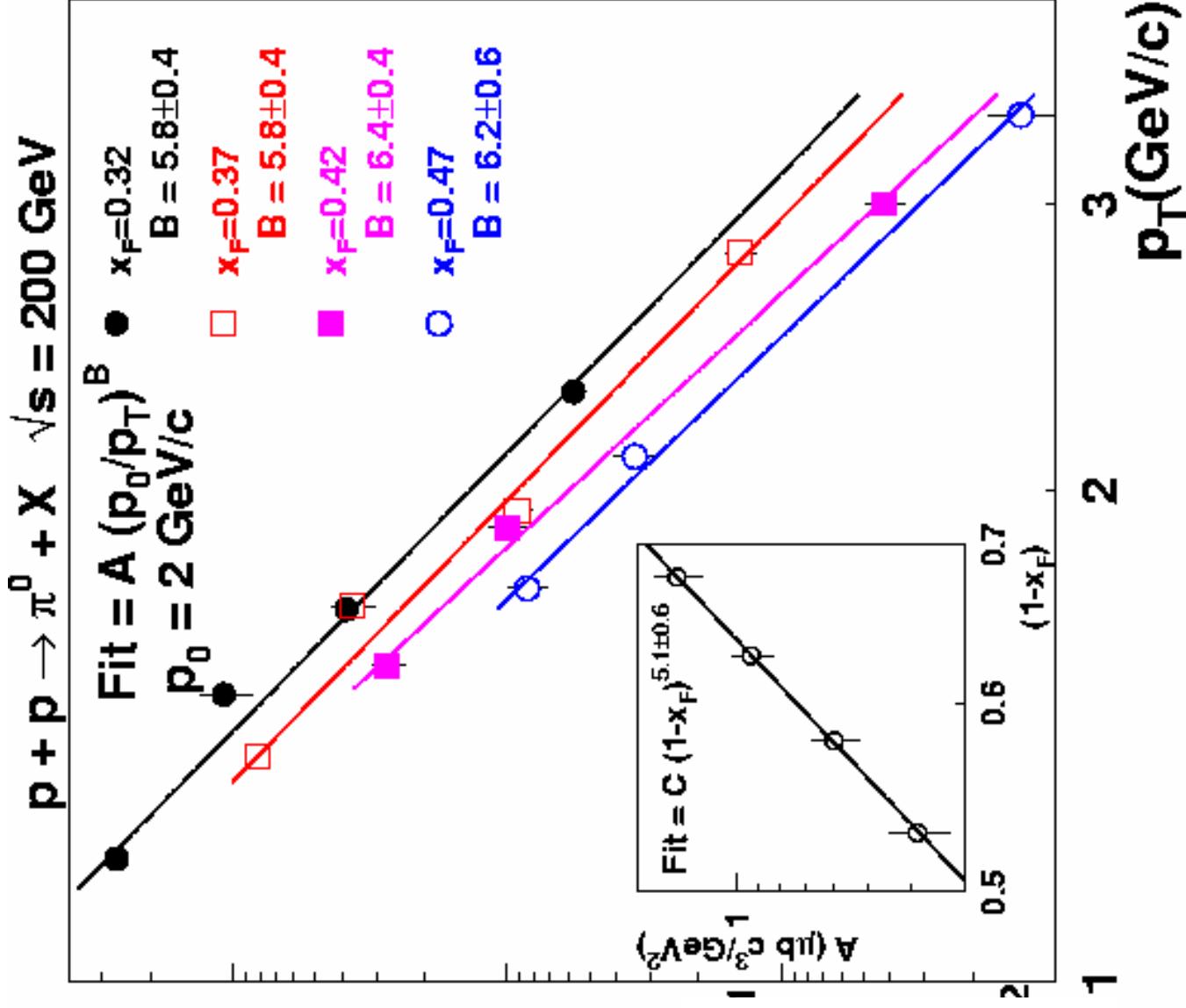

V. Guzey, M. Strikman and W. Vogelsang,
 Phys. Lett. B603 (2004) 173 [hep-ph/0407201].

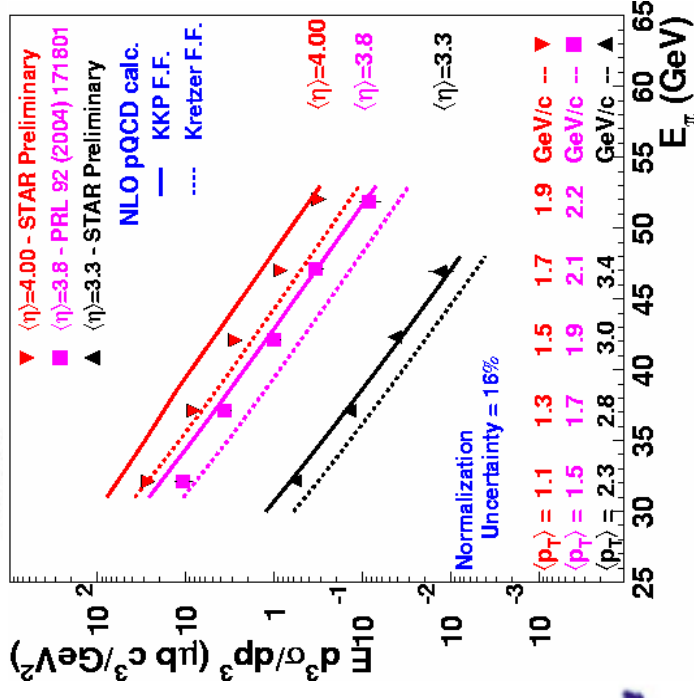
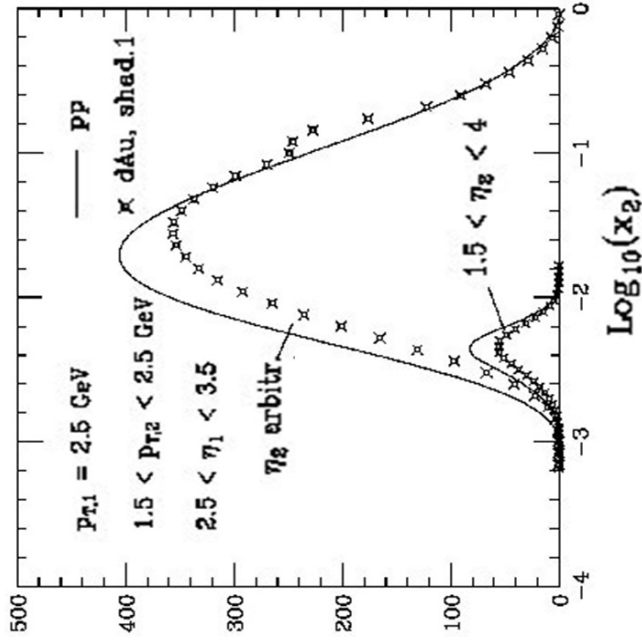

STAR Results

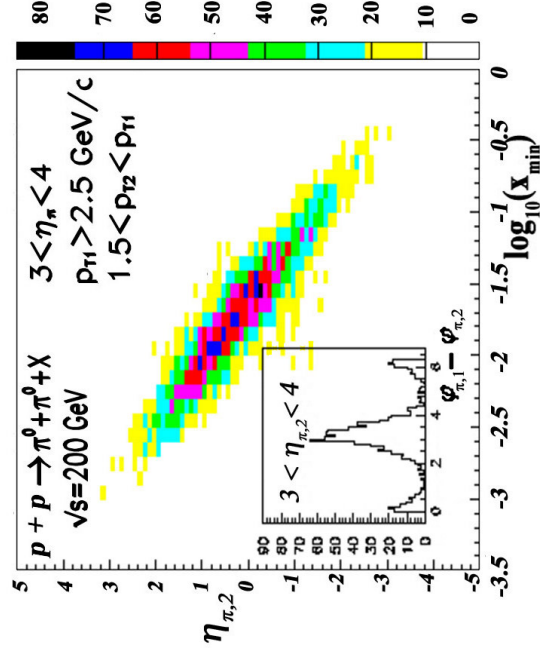
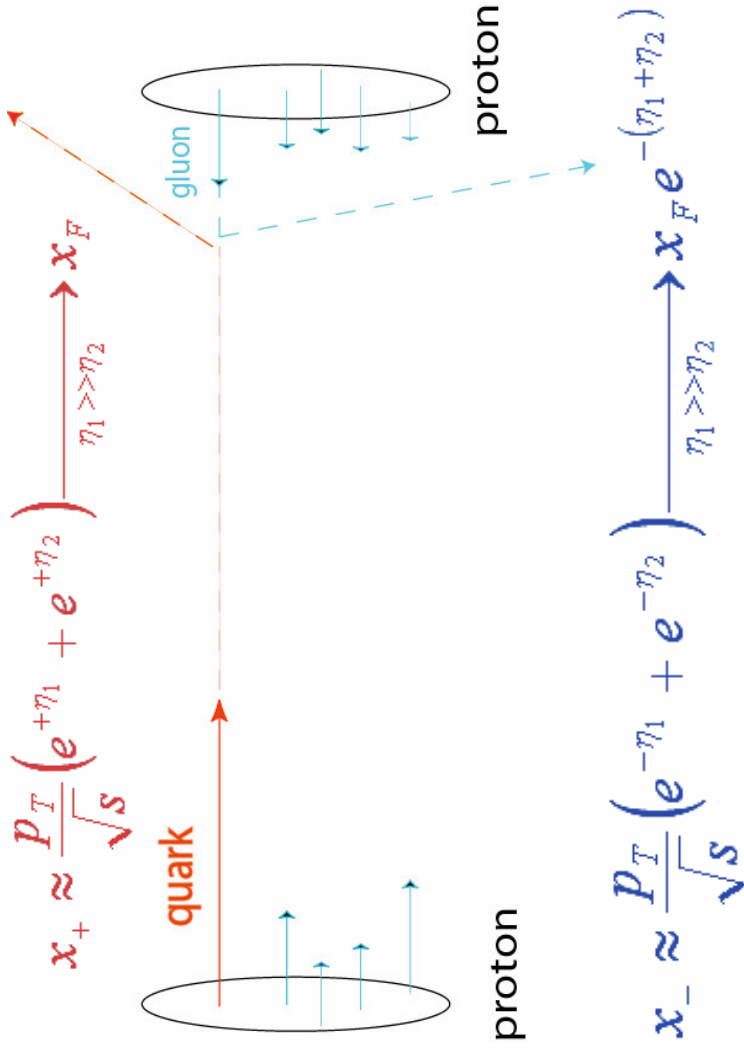

Pythia Simulation

Caveats:

- RHIC CNI Absolute polarization still preliminary.
- Result Averaged over azimuthal acceptance of detectors.
- Positive XF (small angle scattering of the polarized proton).

Run 2 Published Result.

Run 3 Preliminary Result.

- More Forward angles.
- FPD Detectors.

Run 3 Preliminary

Backward Angle Data.

- No significant Asymmetry seen.

(Presented at Spin 2004:

hep-ex/0502040)

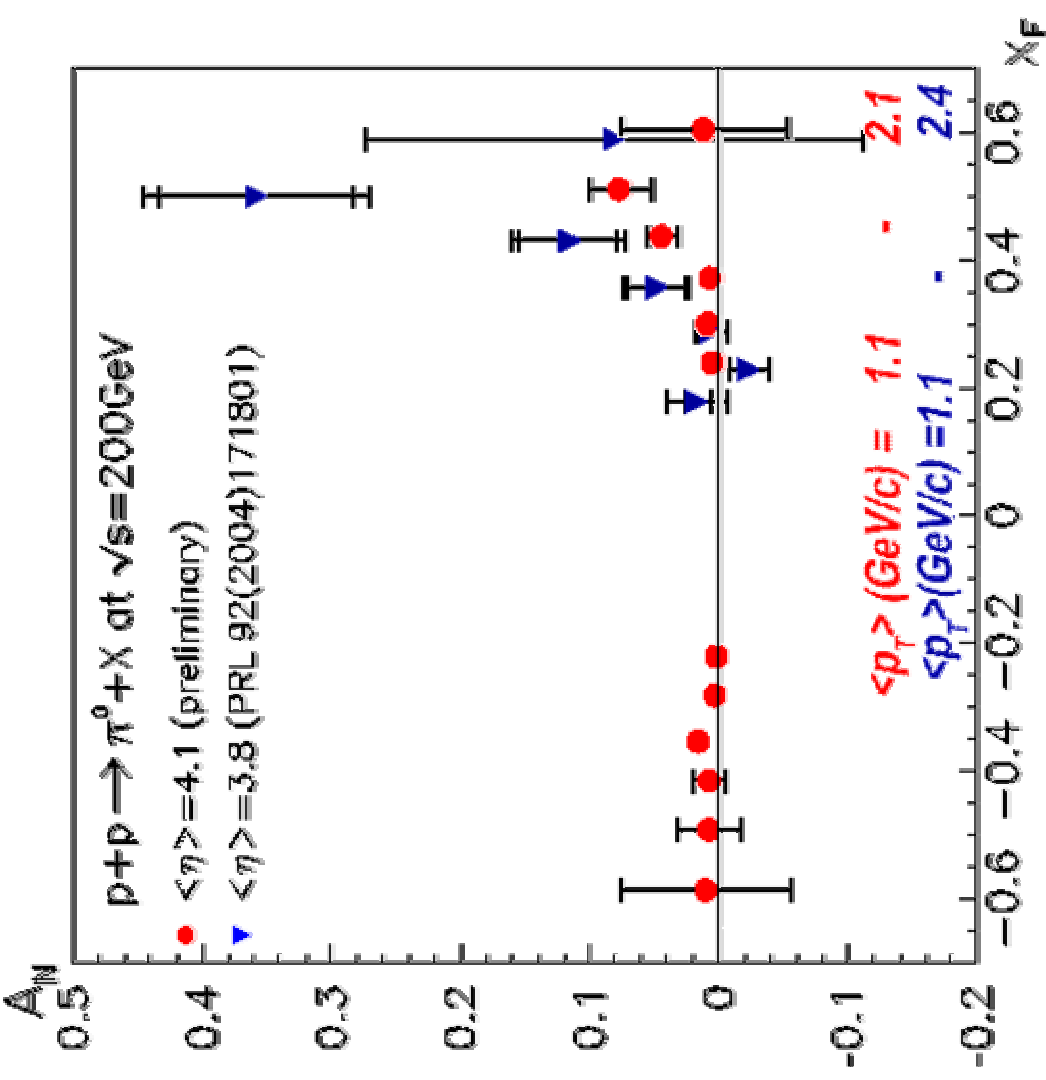

Sivers Effect on two pion correlations.
 Correlation between k_T
 and transverse Spin of proton.

The $\vec{p}_{t1} + \vec{p}_{t2} \sim k_T$ correlated with spin.

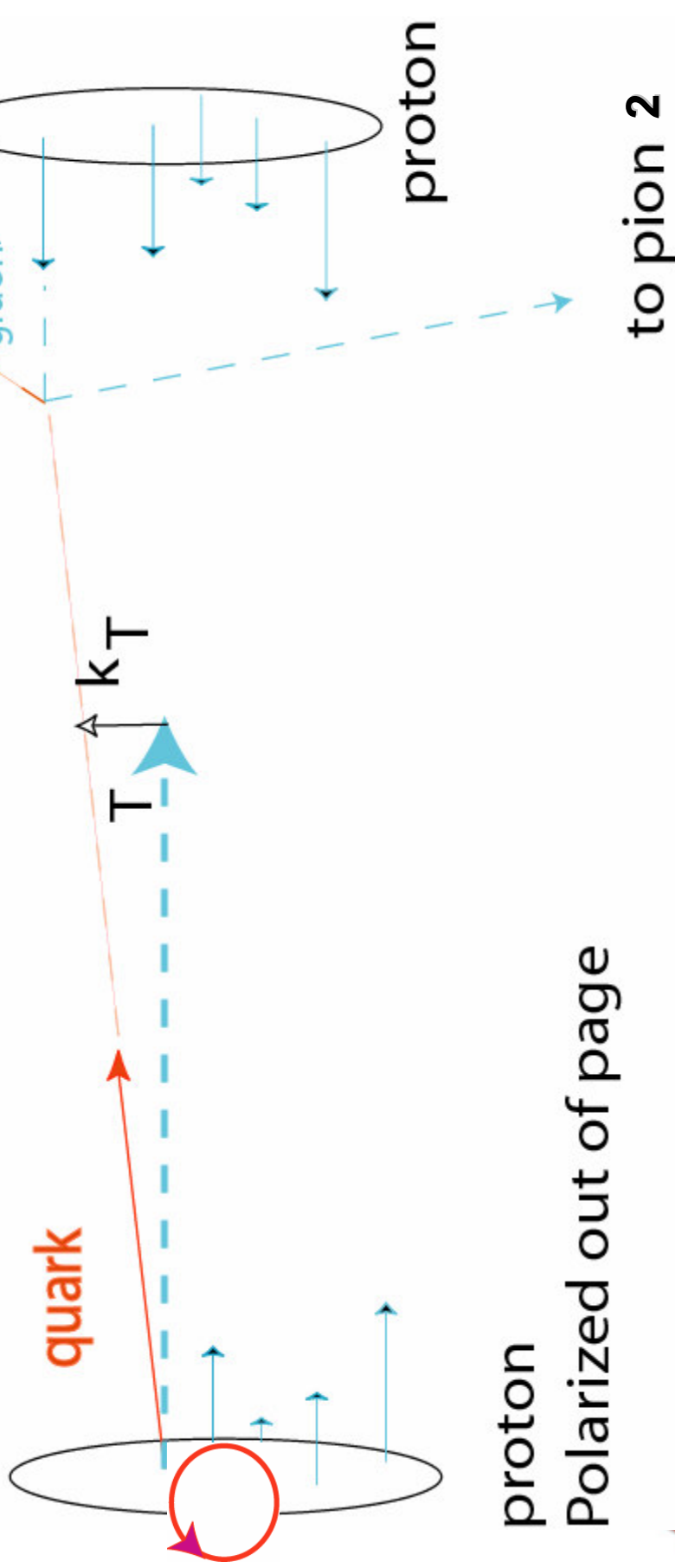

Collins Effect

- **Correlation between transverse spin and transverse polarization of large x quark**
- **Scattering preserves quark transverse spin.**
- **Fragmentation azimuthal dependence gives rise to AN asymmetry.**

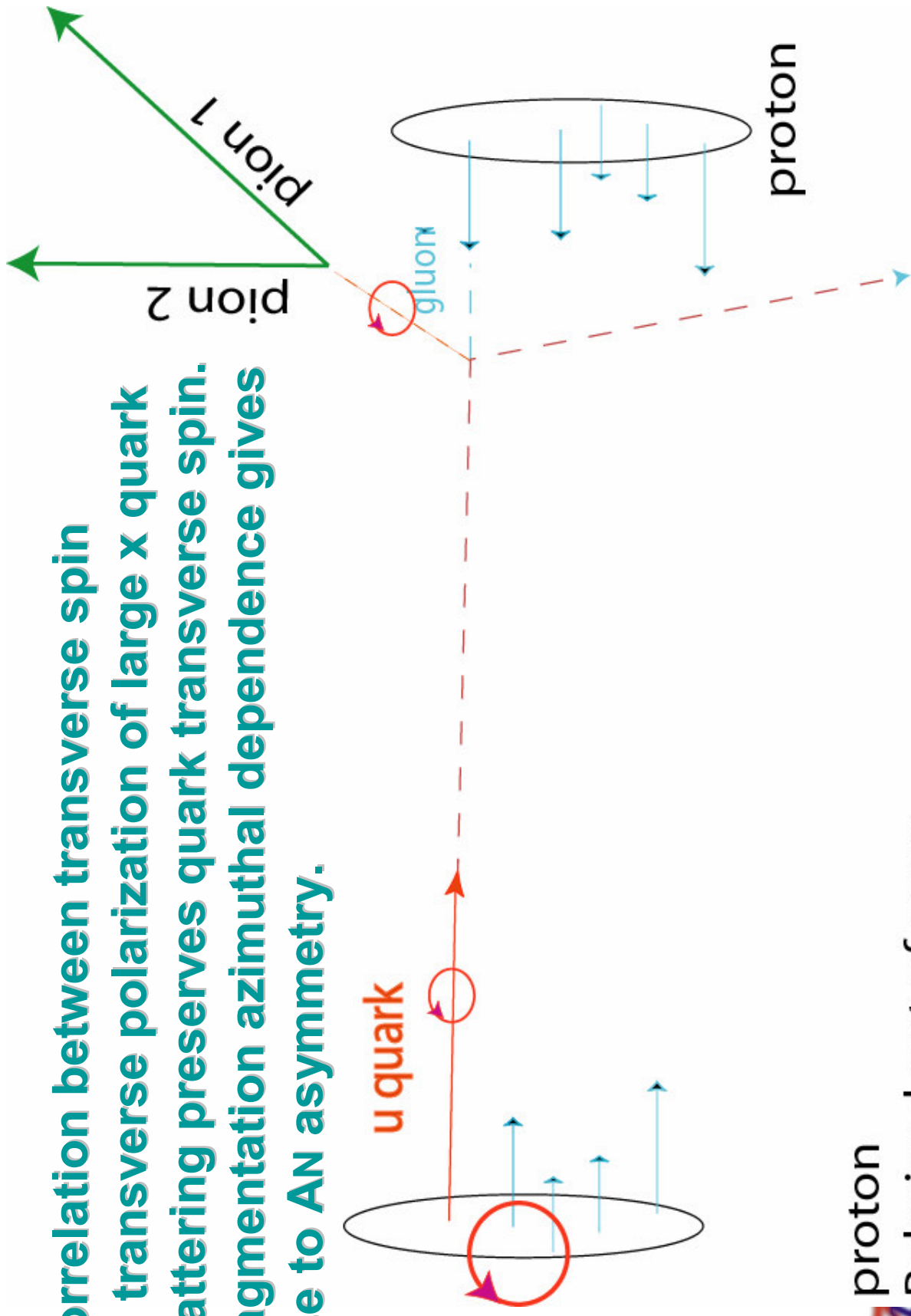

New FMS Calorimeter
Lead Glass From FNAL E831



Loaded On a Rental Truck for Trip To BNL



Plans Near Full Coverage Forward Calorimetry Forward Meson Spectrometer FMS

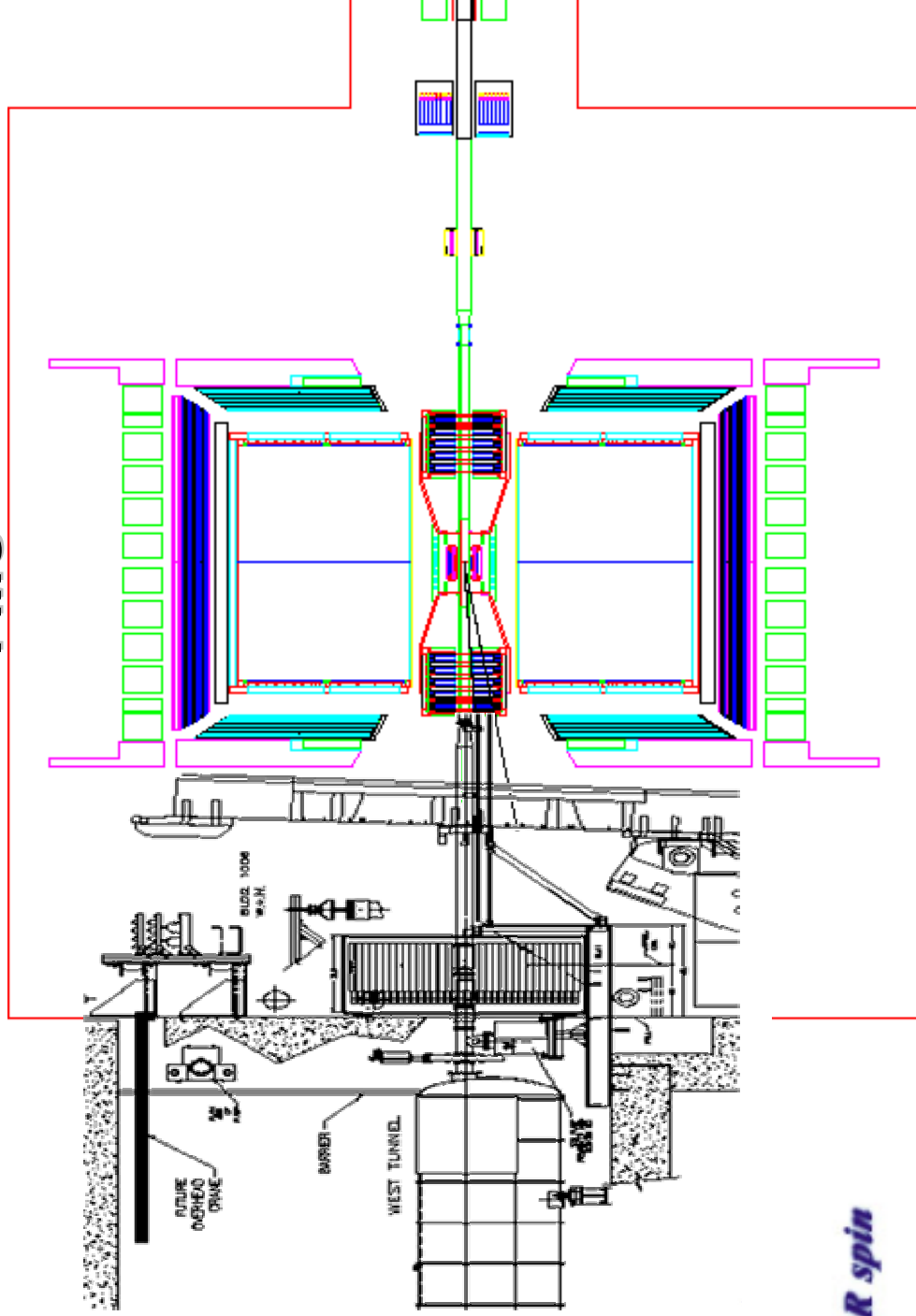

684 X 3.8 cm cells, 756 X 5.8 cm cells
 Include module boundary

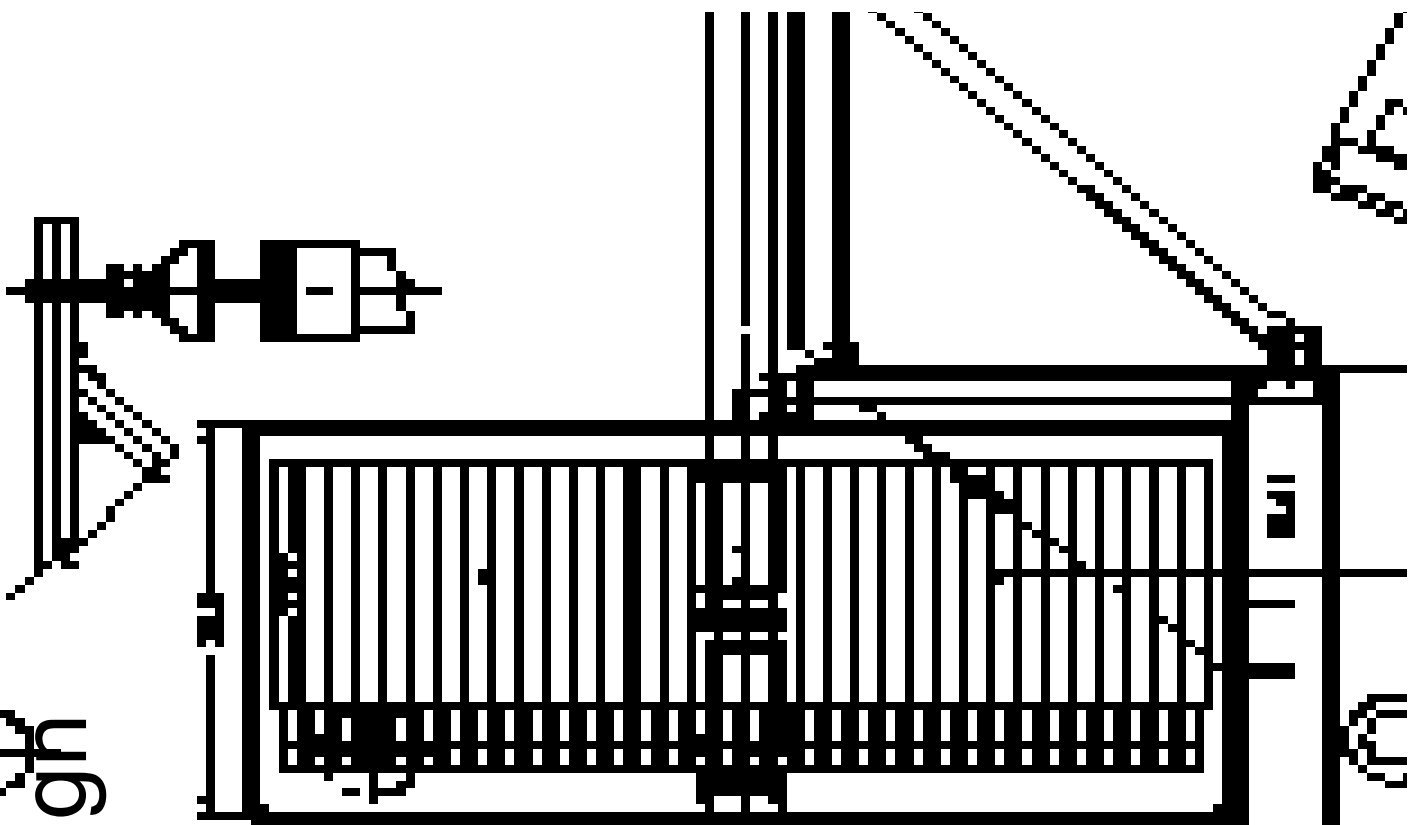
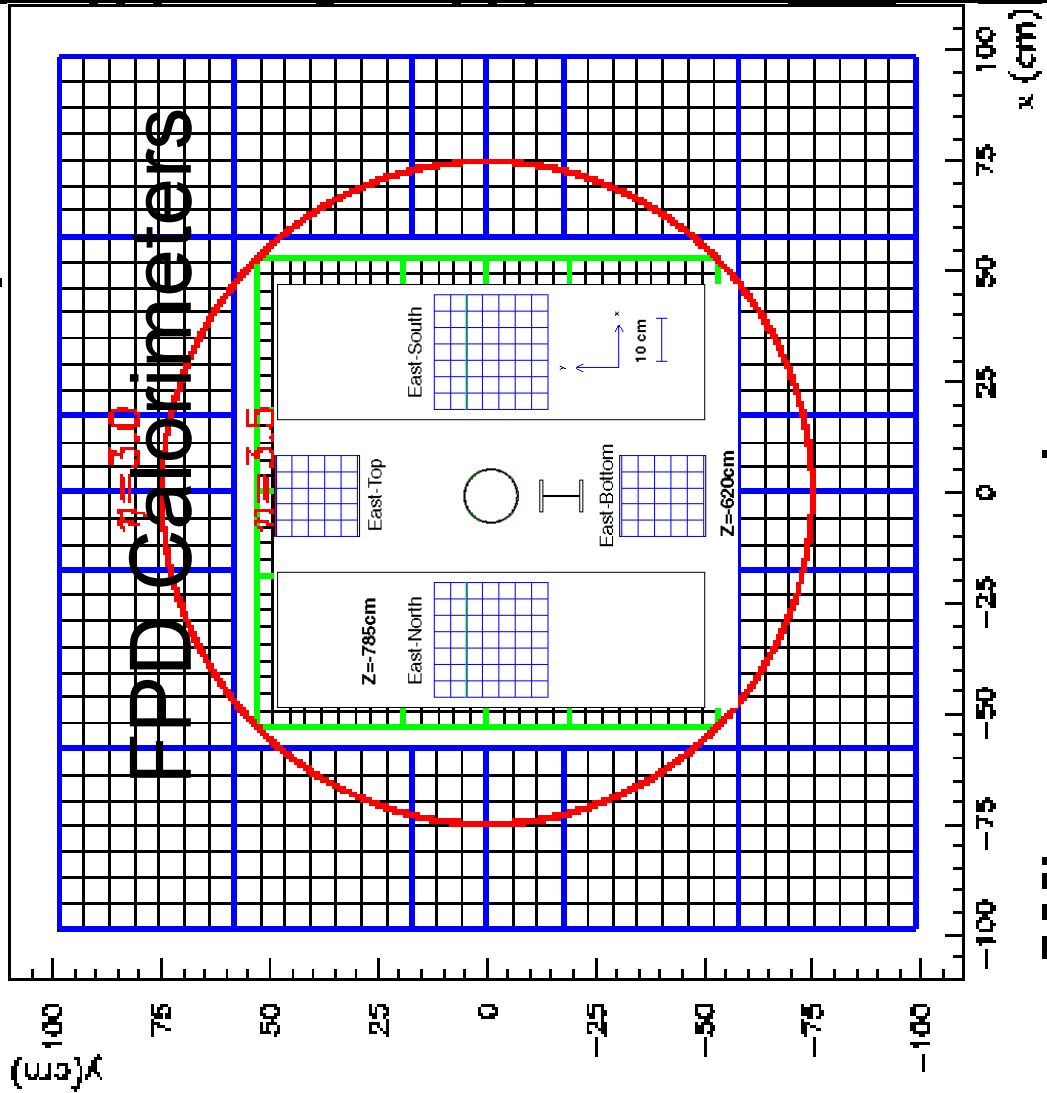

FMS Sensitivity to Gluon distribution, $g(x)$ at $.001 < x < .01$ and $p_T = 2 \text{ GeV}/c$ in p-p and d-Au collisions (Shadowing, Color Glass Condensate ...).

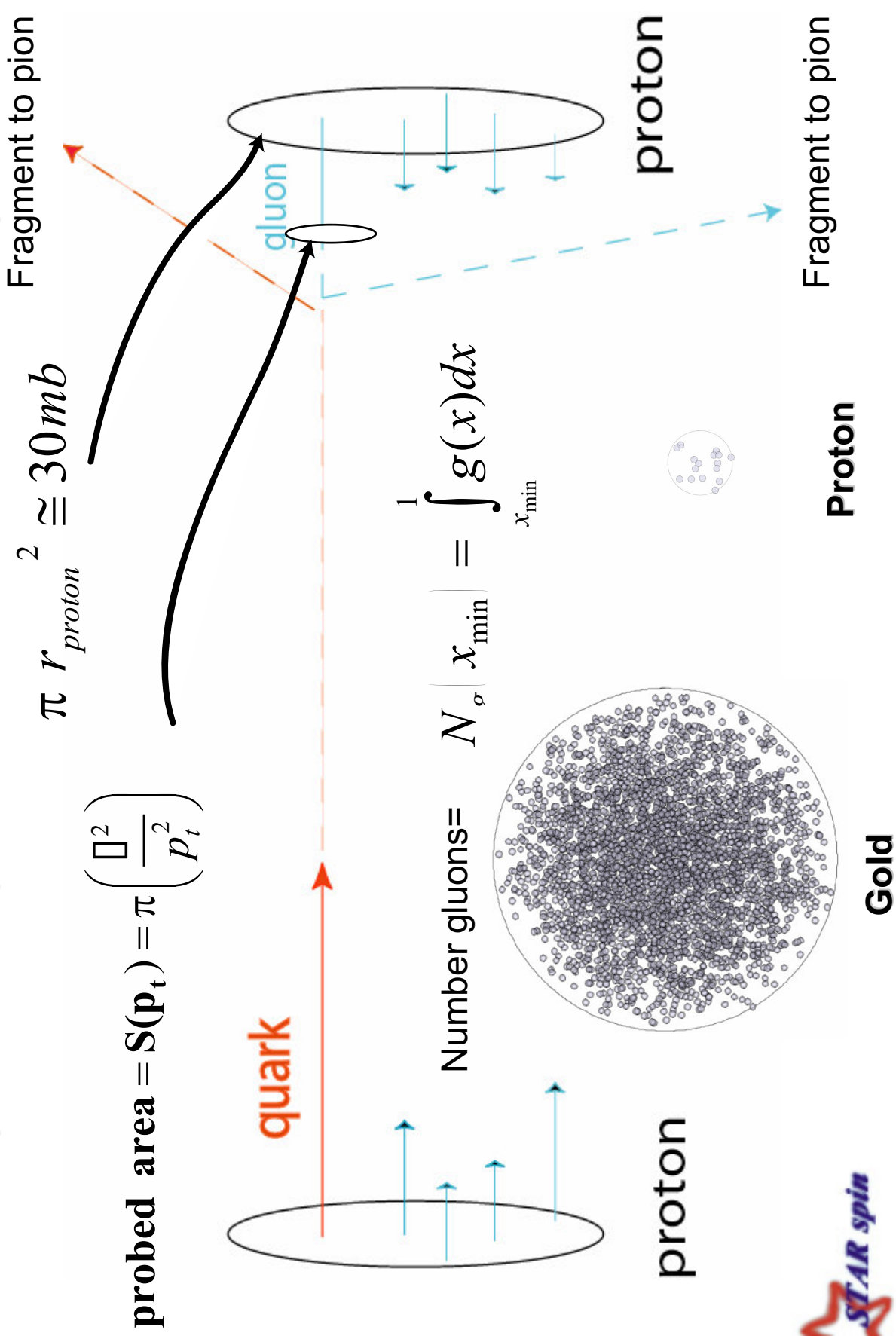

Summary

- **Large spin effects have been observed at forward π^0 production in $p\bar{p}$ (transverse polarization) reaction at high energy ($\sqrt{s} = 200$ GeV).**
- **For forward angles, XF dependence of AN similar to that seen at lower energy.**
- **No significant Asymmetry observed at backward angles.**
- **Inclusive Forward Cross Sections consistent with NLO PQCD calculations (in contrast to lower energy data).**
- **Future measurements (FMS proposal) could resolve origin of A_N and characterization of nuclear shadowing at small x (same kinematic region).**
 - Initial state (Sivers)
 - Final State (Collins).