

Cosmic rays & dark matter with sub-GeV hidden U(1)

Based on : JCAP 02 (2009) 026
In collaboration with Eung Jin Chun

Park, Jong-Chul

KIAS

May 11, 2009

New physics signals from cosmic ray?

- **Positron excess**

HEAT

S. Barwick et al., ApJ **482**, L191 (1997)

AMS-01

M. Aguilar et al., PLB **646**, 145 (2007)

PAMELA

O. Adriani et al., Nature **458**, 607 (2009)

- **$e^+ + e^-$ excess**

PPB-BETS

S. Torii et al., arXiv:0809.0760 [astro-ph]

ATIC

J. Chang et al., Nature **456**, 362 (2008)

H.E.S.S.

F. Aharonian et al., PRL **101**, 261104 (2008)

& arXiv:0905.0105 [astro-ph]

Fermi/LAT

A. Abdo et al., PRL **102**, 181101 (2009)

- **No excess in the antiproton fraction**

PAMELA

O. Adriani et al., PRL **102**, 051101 (2009)

Positron and anti-proton fractions

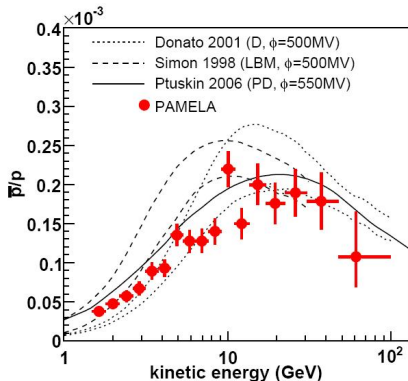
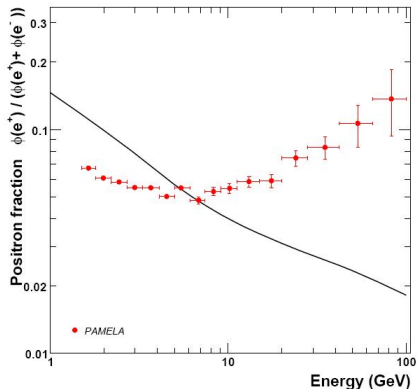

[PAMELA] Nature 458, 607 (2009) & PRL 102, 051101 (2009)

$e^+ + e^-$ spectrum

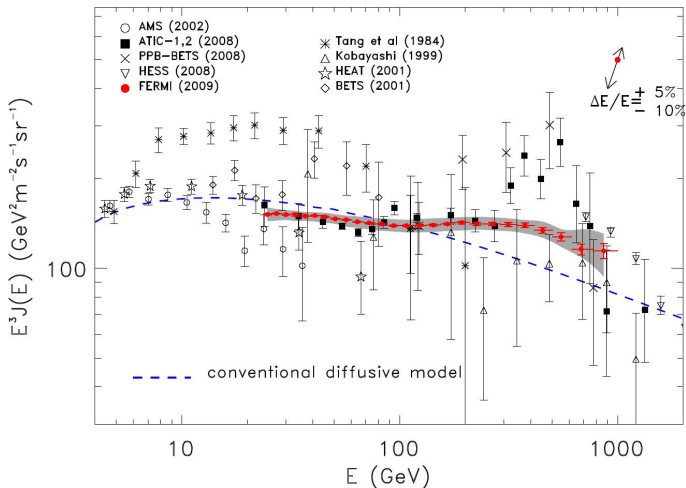

[Fermi/LAT] PRL 102, 181101 (2009)

The origin of excessive energetic e^+ & e^- ?

Candidates of e^+ & e^- source

- **Nearby mature pulsars**

In order to contribute significantly, **not too young** and **old**.

⇒ B0656+14 (290pc, 110000yr) and Geminga (157pc, 370000yr)

D. Hooper et al., JCAP **01**, 025 (2009)

- **Dark matter decay**

Required lifetime $\sim \mathcal{O}(10^{26}\text{s})$

- **Dark matter annihilation**

① Excesses in e^+ & e^- but not in \bar{p}

②
$$\frac{\langle\sigma v\rangle_{\text{Gal}}}{\langle\sigma v\rangle_{\text{Relic}}} \sim 10^2 \left(\frac{M_{\text{dm}}}{500\text{GeV}}\right)^2$$

New DM ideas

- **Leptophilic property**

- ① DM couplings to **only leptons**

- ② DM annihilates to **sub-GeV mediator**. \implies Decay to $p\bar{p}$ is kinematically forbidden. N. Arkani-Hamed et al., PRD **79**, 015014 (2009)

- **Enhanced annihilation in the galaxy**

- ① **Non-thermal DM**

- ② **Local clumps in DM distribution: Λ CDM N -body simulations**

- \implies **BF < 10**

- J. Laval et al., arXiv:0709.3634 [astro-ph]

- ③ **Breit-Wigner resonance**

- ④ **Sommerfeld enhancement:**

Particles with a **light attractive** force carrier ($m_\phi < \alpha m_\chi$). **Slow** incident particles **feel potential more** at $r = 0$. \implies **Enhanced cross section depending on $1/v$** A. Sommerfeld, Ann. Phys. **11**, 257 (1931)

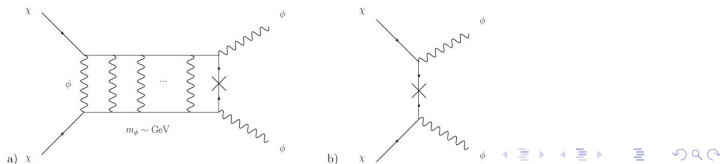

Our framework

E.J.Chun & JCP, JCAP 02, 026 (2009)

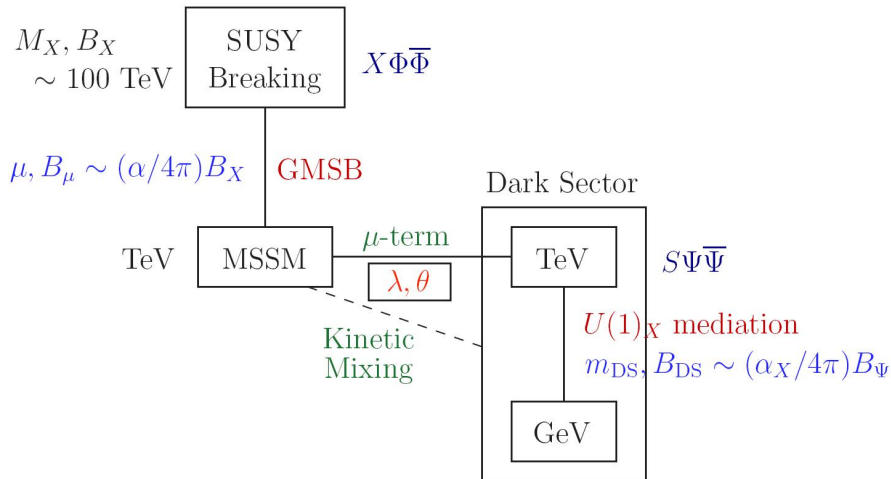

μ -term and dark matter

1 Standard sector

$$W_{\text{standard}} = y_u Q U^c H_u + y_d Q D^c H_d + y_e L E^c H_d + \lambda_H S H_u H_d + \frac{\lambda_S}{3} S^3$$

- ▶ NMSSM and GMSB

$$\mu = \lambda_H v_S \quad , \quad B = \lambda_S v_S \quad , \quad \tilde{m} = \frac{\alpha}{4\pi} \frac{F_X}{M_X}$$

2 Dark sector

$$W_{\text{dark}} = \lambda_\psi S \Psi_{+1} \Psi_{-1} + \lambda_1 \Phi_0 \Phi_z \Phi_{-z} + \lambda_p \Phi_0 \Phi_{pz} \Phi_{-pz} + \frac{\lambda_0}{3} \Phi_0^3$$

- ▶ DM as a TeV messenger in DS: $S \Psi_{+1} \Psi_{-1}$ (cf. $X \Phi \bar{\Phi}$)

$$m_\psi = \lambda_\psi v_S \quad , \quad V_{\text{soft}} = B m_\psi \tilde{\psi}_{+1} \tilde{\psi}_{-1} + h.c.$$

- ▶ GeV masses for X -gaugino & DS scalars

$$m_{\tilde{X}} = \frac{\alpha_X}{4\pi} B \quad , \quad m_{\phi_x}^2 = 2X^2 m_{\tilde{X}}^2$$

DM & Kinetic mixing

- The lighter scalar $\tilde{\psi}_1$ as a DM

$$V = m_\psi^2 (|\tilde{\psi}_{+1}|^2 + |\tilde{\psi}_{-1}|^2) + Bm_\psi (\tilde{\psi}_{+1}\tilde{\psi}_{-1} + h.c.)$$

$$m_{\tilde{\psi}_{1,2}}^2 = m_\psi^2 \mp Bm_\psi$$

- $U(1)_Y$ and $U(1)_X$ can mix

$$\mathcal{L}_{\text{kinetic}} = -\frac{1}{4} (\hat{W}_{\mu\nu}^i \hat{W}^{i\mu\nu} + \hat{B}_{\mu\nu} \hat{B}^{\mu\nu} + \hat{X}_{\mu\nu} \hat{X}^{\mu\nu}) - \frac{\sin \theta}{2} B^{\mu\nu} \hat{X}_{\mu\nu}$$

- Physical basis

$$\begin{pmatrix} \hat{W}_\mu^3 \\ \hat{B}_\mu \\ \hat{X}_\mu \end{pmatrix} = \begin{pmatrix} c_W & s_W & -\frac{c_W s_W m_Z^2}{m_Z^2 - m_X^2} \theta \\ -s_W & c_W & -\frac{c_W^2 m_Z^2 - m_X^2}{m_Z^2 - m_X^2} \theta \\ \frac{s_W m_Z^2}{m_Z^2 - m_X^2} \theta & 0 & 1 \end{pmatrix} \begin{pmatrix} Z_\mu \\ A_\mu \\ X_\mu \end{pmatrix} + \mathcal{O}(\theta^2)$$

Interactions

- Gauge interactions

$$\mathcal{L} = ig_X(X_\mu + s_W\theta Z_\mu)(\tilde{\psi}_1^*\partial^\mu\tilde{\psi}_1 - \partial^\mu\tilde{\psi}_1^*\tilde{\psi}_1) + g_X^2 X^\mu X_\mu \tilde{\psi}_1^*\tilde{\psi}_1$$

$$\mathcal{L} = g' Q_f c_W^2 \theta X_\mu \bar{f} \gamma^\mu f$$

- DM-DM- H interaction

$$\mathcal{L} = -\frac{1}{2}\lambda_H\lambda_\Psi H_u H_d \tilde{\psi}_1 \tilde{\psi}_1^* + h.c.$$

$$\mathcal{L} = \lambda v h^0 \tilde{\psi}_1 \tilde{\psi}_1^*, \quad \text{where } \lambda \equiv \frac{1}{2}s_\beta c_\beta \lambda_H \lambda_\Psi$$

- Assume the dominance of DM- X over DM- H coupling

$$\lambda_H \lambda_\Psi < g_X^2$$

Relic density

- Annihilation through $\tilde{\psi}_1 \tilde{\psi}_1^* \rightarrow XX$

$$\langle \sigma v \rangle_{XX} \simeq \frac{4\pi\alpha_X^2}{m_{\tilde{\psi}_1}^2}$$

- Relic density of $\tilde{\psi}_1$

$$\begin{aligned}\Omega_{\tilde{\psi}_1} h^2 &\simeq \frac{1.07 \times 10^9 \text{ GeV}^{-1}}{M_{pl}} \frac{x_F}{\sqrt{g_*}} \frac{1}{\langle \sigma v \rangle_{XX}} \\ &\approx \frac{2.17 \times 10^{-10} \text{ GeV}^{-2}}{\langle \sigma v \rangle_{XX}}\end{aligned}$$

- Constraint from relic density

$$\Omega_{\text{DM}} h^2 \simeq 0.1143 \implies \alpha_X \simeq 1.58 \alpha (m_{\tilde{\psi}_1} / \text{TeV})$$

Sommerfeld factor

$$-\frac{1}{m_{\tilde{\psi}_1}} \frac{d^2 \tilde{\psi}_1(r)}{dr^2} - \frac{\alpha_X}{r} e^{-m_X r} \tilde{\psi}_1(r) = m_{\tilde{\psi}_1} \beta^2 \tilde{\psi}_1(r)$$

$$S = |\tilde{\psi}_1(\infty)/\tilde{\psi}_1(0)|^2 \quad \tilde{\psi}_1'(\infty)/\tilde{\psi}_1(\infty) = im_{\tilde{\psi}_1}\beta$$

- 1 $S \sim 50$ for $m_{\tilde{\psi}_1} \approx 700$ GeV
- 2 Combined effect with BF $\lesssim 10$ from clumpy DM distribution

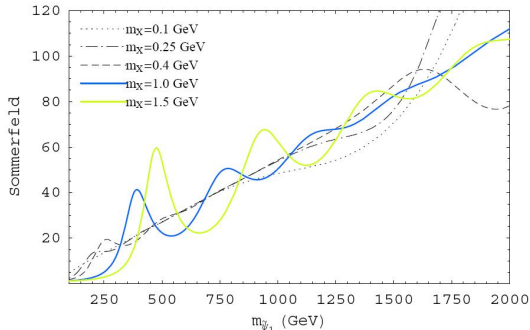

Conclusion

- Leptonic excesses in cosmic rays may reveal the identity of DM.
→ Require brand new ideas?
- Sub-GeV $U(1)_X$ dark sector can be realized in GMSB scheme.
- Required boost factor can be obtained from combination of Sommerfeld effect and DM clumps.

Thank You!

Direct detection

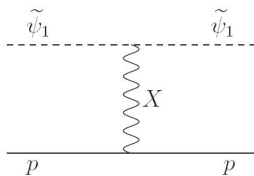

(a) vector interaction

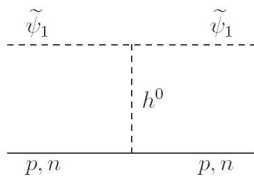

(b) scalar interaction

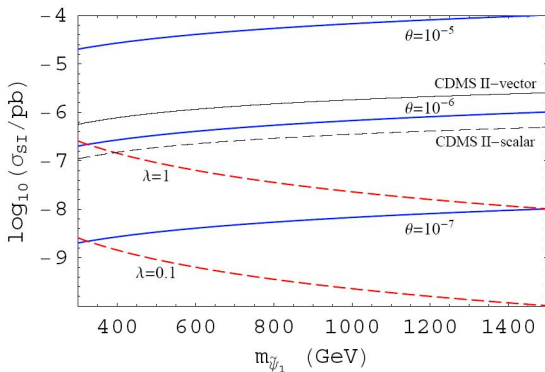

LHC signatures

- OLSP decay

$$\mathcal{L} = \frac{1}{2}(C_1 + C_2)\bar{\tilde{X}}\sigma^{\mu\nu}\tilde{S}X_{\mu\nu} \quad C_i = \frac{m_\psi}{16\pi^2 m_i^2} \frac{\lambda_\psi g_X^2}{\sqrt{2}} J(x_i)$$

$$\Gamma(\tilde{S} \rightarrow X\tilde{X}) = \frac{1}{8\pi} m_S^3 (C_1 + C_2)^2 \approx \frac{\lambda_\psi^2 \alpha_X^2}{2304\pi^3} \frac{m_S^3}{m_\psi^2}$$

- Displaced vertices of lepton pairs

$$l_{\tilde{\chi}_1^0 \rightarrow X\tilde{X}} \approx \left(\frac{0.1}{c_S}\right)^2 \left(\frac{0.1}{\lambda_\psi^2}\right) \left(\frac{200 \text{ GeV}}{m_{\tilde{\chi}_1^0}}\right)^3 \times 10^{-3} \text{ cm}$$

$$l_{X \rightarrow f\bar{f}} \approx \left(\frac{1}{Q_f}\right)^2 \left(\frac{10^{-6}}{\theta}\right)^2 \left(\frac{0.4 \text{ GeV}}{m_X}\right) \times 25 \text{ cm}$$

$$l_{\tilde{\chi}_1^0 \rightarrow \gamma\psi_{3/2}} \approx \left(\frac{\sqrt{F}}{10^5 \text{ GeV}}\right)^4 \left(\frac{200 \text{ GeV}}{m_{\tilde{\chi}_1^0}}\right)^5 \times 3 \times 10^{-4} \text{ cm}$$

